

PROFINET

Safety for the future

Products 

Diagnosis 

Monitoring 

Training 

Consulting 

Network-Services 



PROFI
NET

PROmesh Switches

superior quality performance and versatility
in the application

- + Keep an eye on the condition of the system or the network section – seamless and traceable at all times.
- + Localize detected interference sources - without additional measuring devices or Loss of time due to manual measurement effort.



Content

Industry 4.0 – New challenges for automation	4
Basics	6
Standards and guidelines	7
PROFINET Design Guideline and Commissioning Guideline	7
Parameters for network planning	8 – 9
PROnetplan network planning software V2	10 – 11
ETHERtest V5 and PROlinetest cable tester	12
PROscan® Active V2 acceptance test and validation software	13 – 16
PROFINET-INspektor® NT analysis and diagnostic tool	17 – 20
PROFINET DiagnosticDUO (PROscan® Active V2 & PROFINET-INspektor® 1G)	21
EMCheck® LSMZ I leakage current measuring clamp	22
PROFINET Diagnostic set	22
iPNMA intelligent measuring point	23
PROmanage® NT network monitoring software	24 – 26
Configuration example (permanent network monitoring)	27
PROmesh Switch product family	28
Increased network diagnostics with the PROmesh P product family	29
19" switches - the connection to IT	30
PNMA II / PNMX PROFINET measuring points	31
SIEDS + D*Bridge - „Bridge to digitization“	32 – 33
Analysis Diagnostics Measurement	33
Infrastructure components	34 – 35
SIEDS + D*Bridge	36
Analysis, Diagnosis, Messure	37 – 38
Network Monitoring EMC infrastructure components	39
Network services	40 – 43



Industry 4.0 – New challenges for automation

The 4th industrial revolution – also known as Industry 4.0 – describes a development where production companies increase the degree of networking and automation in their value creation chain so high that intelligent machines and systems can process digital product information automatically for the most part and increasingly organise processes autonomously. In this manner, even single pieces can be manufactured according to individual sizes (so-called batch size 1) within a reasonable economical range and thus open up new markets.

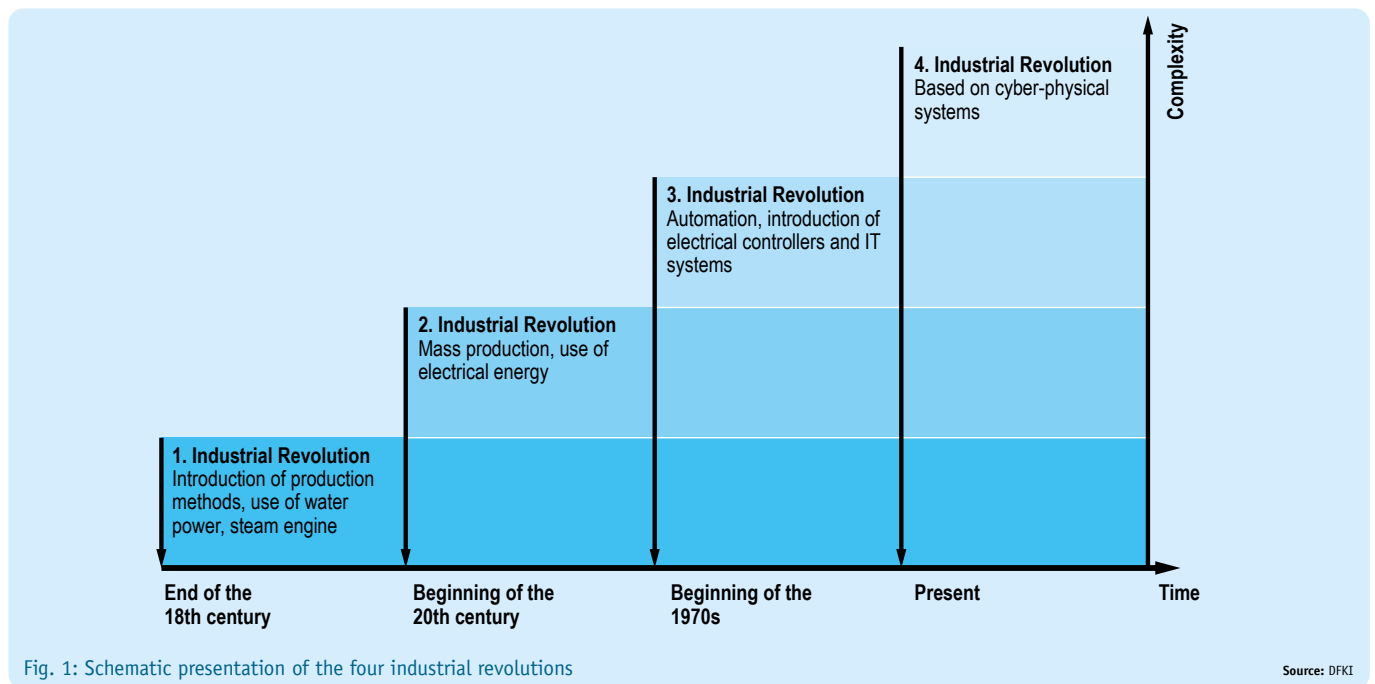

Prof. Dr. Henning Kagermann (German Academy of Sciences), Prof. Dr. Wolf-Dieter Lukas (Federal Ministry for Education and Research) and Prof. Dr. Wolfgang Wahlster (German Research Centre for Artificial Intelligence) went public in 2011 with the “Initiative Industry 4.0” and thus coined a term that has found rapid increased use since. By establishing the “Platform Industry 4.0” (2013) for the coordination of the developments, the federal government has declared this as a topic for top management.

In practical application, it is becoming clear that Ethernet-based networks such as PROFINET will gradually replace field-bus technology and thus become the pathfinder for Industry 4.0 at the production level (operational technology, OT). Networks, which still have a mostly local structure today, will in the future grow together from the classically hierarchic structure of the automation pyramid into a large, complex network of decentralised distributed intelligences (so-called cyber-physical systems, CPS) (see Fig. 2 and 3).

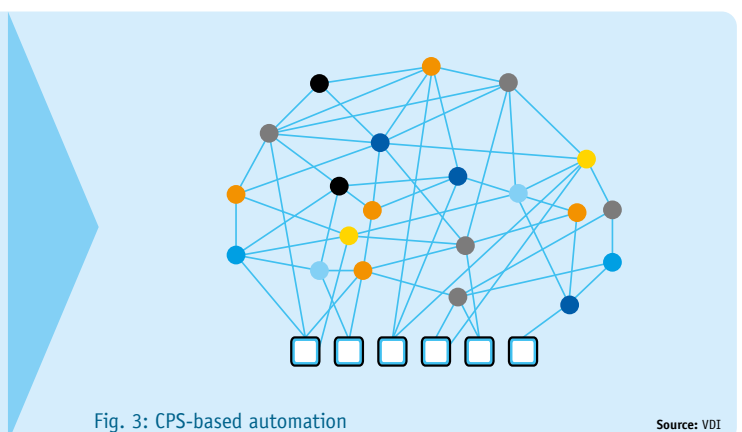
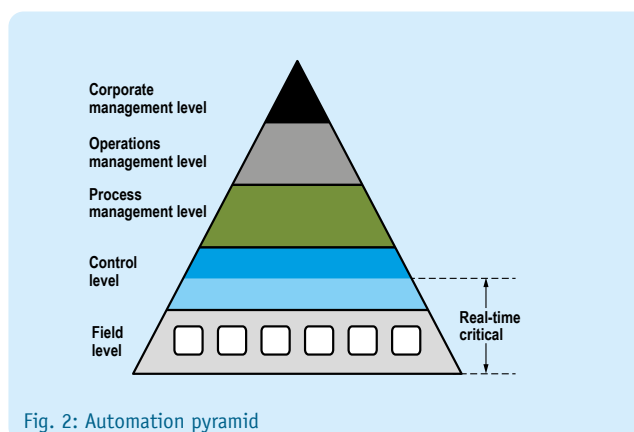

In the face of a vast array of solutions offered by industrial Ethernet-applications, the challenge lies in finding a common system without communications obstacles that satisfies all requirements. It is becoming clear that in the future more interest will be focussed on standard Ethernet and different, parallel existing protocols will drop away. The IEEE task force TSN (Time Sensitive Networking) was created to give real-time capability to standard Ethernet.

Security aspects are gaining importance as well (see below). Thanks to the advances of digitisation, production is increasingly controlled by data that is provided by intelligent sen-

sors and devices. This data can be retrieved directly from the office level (information technology, IT), which likewise communicates via Ethernet. External (unauthorised) access is possible just as well however.

In order to understand data flows under the conditions of an increasing blending of IT and OT and to ensure security, it is becoming increasingly important to know:

Who communicated what with whom when by which means?



Security for Automation 4.0

The blending with IT however does not permit the acceptance of its security measures for the automation technology. The task for IT is rather to prevent unauthorised external access to data whereas automation technology places its focus on attacks „from inside“. Whether they are own staff or visiting service technicians – they can, possibly even unintentionally, cause quality-relevant incidences by supposedly harmless actions such as an active network scan or the loading of firmware updates.

Currently such accesses to the network cannot be regulated without endangering its availability. The correct concept by IT of shielding off to the outside for protecting the data is, however, in direct contrast to the point of view of automation technology with its idea of increasing networking of customers and producers in the whole world. The events need to be recorded though to recognise their causes and to even notice such attacks.

Today's approach by Indu-Sol is based on the log analysis by permanent network monitoring (PNM). In combination with the network monitoring software **PROmanage® NT** (see page 24), the passively operating measurement and diagnostic tool **PROFINET-INspektor® 1G** (see page 17) thereby analyses the logical data traffic in the network. Anomalies, such as unknown participants in the network or delays in the data transmission (so-called jitters, see page 8), are reported immediately.

When these quality-relevant events are recorded additionally and kept on hand, the operator knows at any time what is going on in his network.



Basics

PROFINET is a universal, Ethernet-based communication network that can be used in all areas of automation technology. Speedy vertical and horizontal data exchange across all levels – including the corporate control level – is the foundation for successful systems concepts.

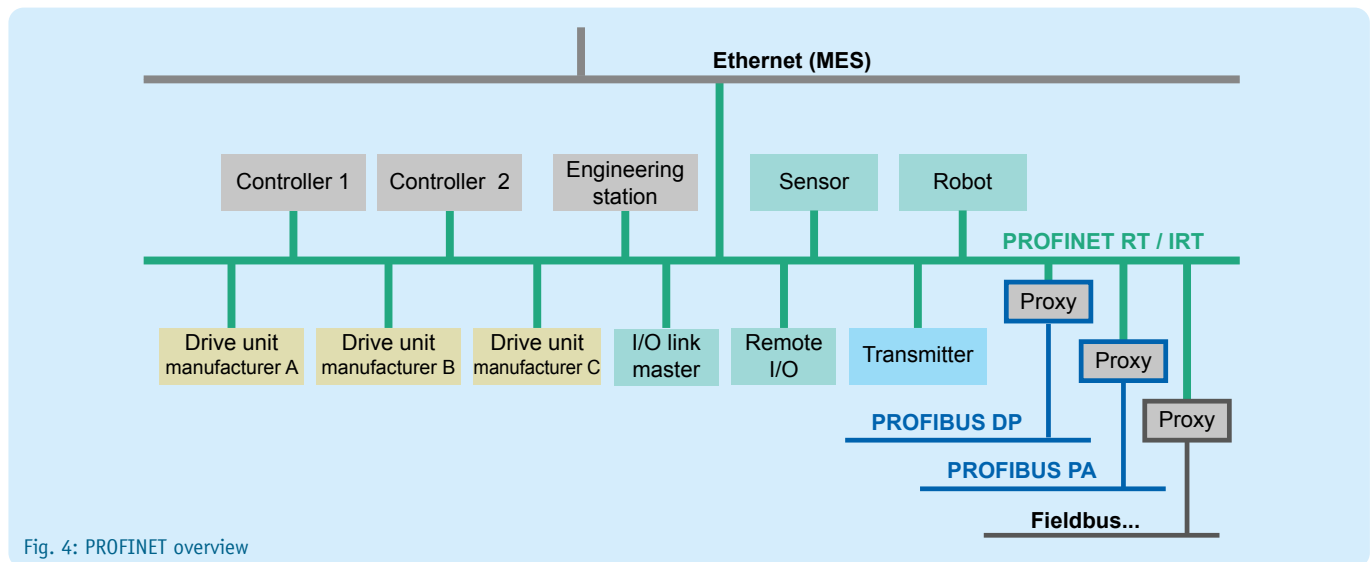

Fig. 4: PROFINET overview

Like PROFIBUS, PROFINET distinguishes between acyclical and cyclical data communication (RT – Real Time) and additionally supports fast I/O communication (IRT – Isochronous Real Time). This is done while retaining the familiar design with a cyclical transfer of peripheral data between the field devices (IO devices) and the process image in the IO controller. This results in a high degree of flexibility because update rates are scalable (see Fig. 5).

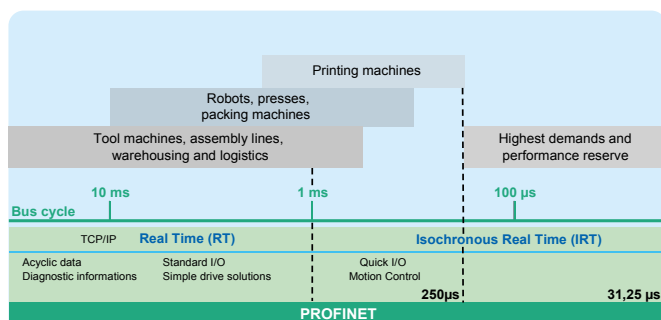

Fig. 5: Scalable bus cycle times (RT and IRT) in PROFINET

PROFINET describes a device model that is based on the principles of PROFIBUS and consists of slots and groups of IO channels (sub-slots). The technical characteristics of the field devices are described by a so-called GSD (General Station Description) that is based on XML.

Data in PROFINET networks is highly varied. Besides prioritized, cyclical PROFINET I/O data, acyclical data (e.g. TCP/IP, diagnostic messages or SNMP requests) can be transmitted (see Fig. 6).

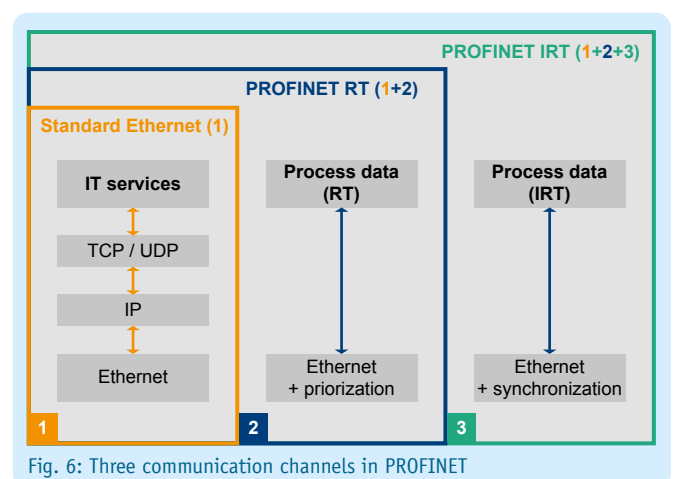

Fig. 6: Three communication channels in PROFINET

Network topologies in PROFINET derive from the requirements of the systems to be networked. The most common structures are star, line, tree and ring-shaped. In practice, systems usually are a mix of the above structures. They can be implemented either with copper or fiber-optic cables.

Standards and guidelines

Criteria for quality evaluation in the PROFINET are based on the following list of standards and guidelines as well as the experience of **Indu-Sol GmbH**. Observing them is the basis for any measurement, planning, acceptance inspection and commissioning.

- PROFINET Design Guideline – Version 1.38 – September 2019
- PROFINET Commissioning Guideline – Version 1.44 – September 2019
- PROFINET Assembly Guideline – Version 2.8 – September 2019
- PROFINET I/O Security Level 1 (netload) – Version 1.2.1.1 – February 2017
- PROFINET Conformance Classes – Version 1.1 – March 2011
- EN 50173 / ISO IEC 11801 – Structured cabling systems
- EN 50310 – Application of equipotential bonding and earthing in buildings with information technology equipment
- VDI / VDE Guideline 2184 – Reliable operation and maintenance of fieldbus systems
- Functional grounding and shielding of PROFIBUS and PROFINET – Version 1.0 – March 2018

PROFINET Design Guideline and Commissioning Guideline

The extensive options for configuration and utilization of a network necessitate careful planning and practice-oriented commissioning of the system. The user organization PROFIBUS & PROFINET International (PI) has defined quality criteria for planning, acceptance and commissioning, as well as the metrological evaluation of a network in its latest **Design and Commissioning Guideline**. It is intended as a guideline for all persons and organizations involved in the planning, installation, operation and maintenance of such systems.

In the planning stage, network utilization should be considered in addition to structure. For this purpose, it is important to know the relationships between update rate, line depth and network structure. Practical planning tools like **PROnetplan** by **Indu-Sol** can be used to display such relationships in an interactive graphic to avoid weak spots.

Moreover, it is useful to define the requirements for IO devices in advance. The categorization in Conformance Classes (CC-A, CC-B, CC-C) is a useful aid to users when selecting devices that have no more than the required functionality. Requirements include simultaneous access to devices by several controllers (IO controllers), support for media redundancy, detection of topology information in the network, device exchange without repeated use of a parameterization device, as well as applications with very short cycle times and low variation.

The selection and placement of network components in the network structure depends on the performance of the devices. It is described by the net load classes (IO Security Level 1 – see the “standards and guidelines” box).

The years of experience with fieldbus technology have shown that the extensive diagnostic options of controllers in the area of device diagnostics should be expanded by an additional measurement to verify the quality of communication. The measurements serve as dual purpose, namely a description of the PROFINET network on the one hand and ensuring operational reliability on the other. Special attention should be paid to assuring the quality of the line connections (test when plant is stopped) as well as the transmission during operation.



RECOMMENDATION

In order to ensure reliable long-term functionality of the plant, measurements to verify compliance with the quality requirements (pages 9 and 19) are urgently recommended.



Parameters for network planning

Planning the network structure

The key properties of PROFINET are a variable network structure and the unlimited combinations provided by exploiting all topological shapes of the standard Ethernet. The topology results from the following criteria:

- Spatial arrangement of the components
- Distances to be bridged
- Requirements for the use of primary infrastructure / increased availability
- Consideration of netload (netload planning) and TCP/IP traffic
- Update rate in consideration of line depth
- Communication quality and telegram traffic
- Requirements for potential isolation/EMC

Selecting the right topology is important for the further planning of a PROFINET automation system. If required, the topology has to be adapted in a later inspection step.

Sources: PI Design Guideline (V 1.38/Sep. 19) pp. 51-56
PI Commissioning Guideline (V 1.36/Dec. 14) pp. 91/92

Update time

The update rate is the interval at which the data between the controller and IO device is updated. It can be set individually for each device in the controller (standard setting: 2 ms). In addition to considering the requirements of the process, also consider the PLC cycle time. Indu-Sol recommends setting the update time for devices to at least half the PLC cycle time. The guiding principle is **“Update only as necessary – not as much as possible.”**

The switching behavior of each device and the installed line depth, i.e. the number of passing devices (switches and IO devices with integrated switches) on the line, are critical for compliance with the update rate. An increasing number of passing devices prolongs the duration of the telegram. The variation of the real from the set update rate keeps increasing. It is called **“jitter”** and indicated in percent. Measurements to show compliance with the set update rates and their variation may serve as a basis for an assessment of system stability and provide an early warning of potential weak spots.

Sources: PI Design Guideline (V 1.38/Sep. 19) pp. 96-98
PI Commissioning Guideline (V 1.36/Dec. 14) p. 104

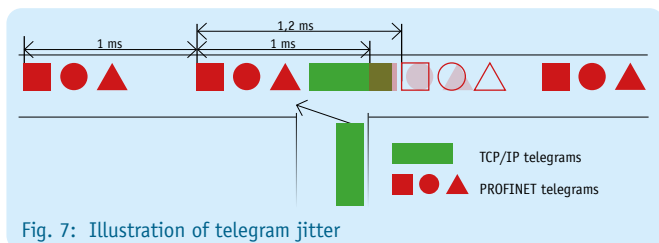

Netload

The cyclical netload generated by each PROFINET device has a maximum in the connection between the controller and the first device. In order to permanently ensure the flawless functioning of the PROFINET network the following tolerances for planning and realization have to be ensured:

Netload	Recommendation
< 20%	No action required
20% ... 50%	Review of planned netload is recommended
> 50%	Take action to reduce netload

It can be seen from the practical applications that the existing netload consists of both PROFINET and TCP/IP communication. Although the PROFINET communication is generally prioritized at switches (network nodes), TCP/IP communication may sometimes jump the queue. Whether and to what extent this happens – or can happen – can be seen from the load ratio (PROFINET to TCP/IP communication). Since different netloads (peak loads) affect the compliance with update rates and devices of different netload classes are especially sensitive to peak loads demonstrating the network quality in consideration of utilization is especially important during the acceptance test or troubleshooting of a system.

Sources: PI Design Guideline (V 1.38/Sep. 19) pp. 114-117
PI Commissioning Guideline (V 1.36/Dec. 14) pp. 95/96

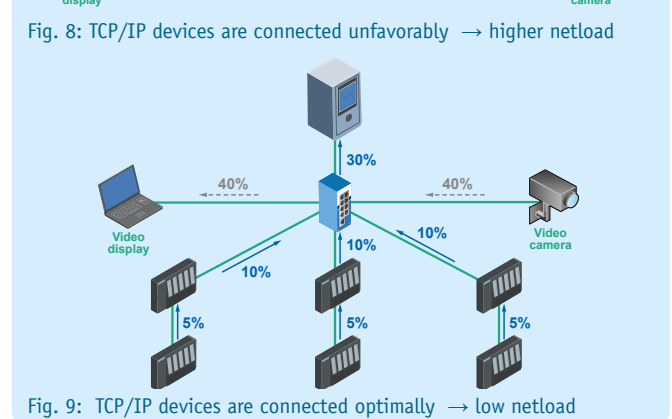
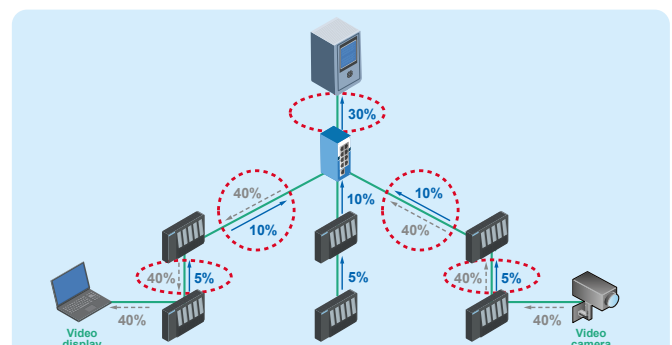

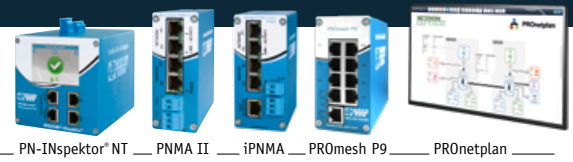

Line depth

Because in PROFINET (RT) it cannot be determined whether a device (switch) is operating in store-and-forward or in cut-through mode a delay has to be expected for every passing device.

This delay has to be considered when designing a network in the planning phase. Fundamentally, the maximum line depth depends on the update time and the switch mode (see the "line depth" tables). Indu-Sol recommends observing the values from the PI guideline "Line depth for store-and-forward switches".

Source: PI Design Guideline (V 1.38/Sep. 19) pp. 110-113

Line depth for store-and-forward switches

Max. line depth for update time of			
1 ms	2 ms	4 ms	8 ms
7	14	28	58

Access points

When planning PROFINET networks the guideline recommends passive access points for network diagnostics.

Why?

- During commissioning or maintenance, to analyze the network traffic or read out devices
- To connect diagnostic devices during running operation without interruption
- For troubleshooting or long-term diagnosis/preventative maintenance of the network condition

How?

- Using passive, feedback-free TAPs (e.g. PROFINET measuring points PNMA II/PNMX – see page 31)
- Using a smart TAP (e.g. PROFINET-INspektor® 1G/iPNMA – see page 17,23)

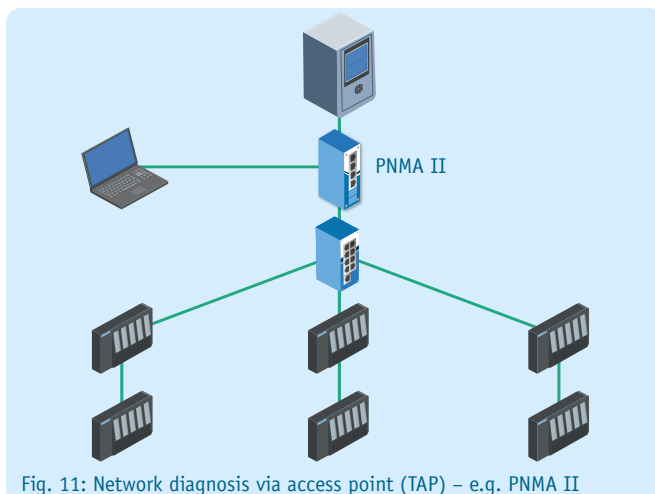

Fig. 11: Network diagnosis via access point (TAP) – e.g. PNMA II

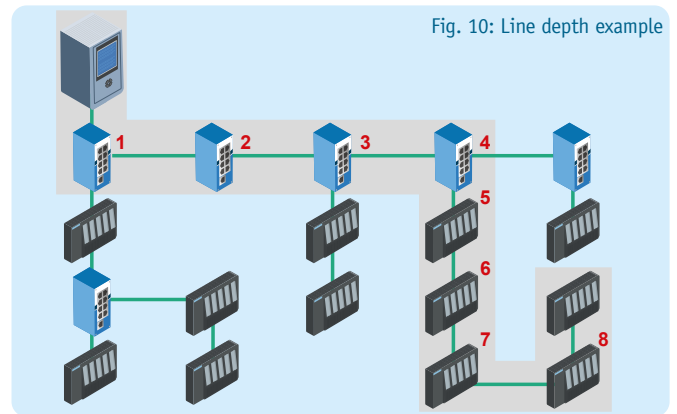

Fig. 10: Line depth example

Line depth for cut-through switches

Max. line depth for update time of			
1 ms	2 ms	4 ms	8 ms
64	100	100	100

Please note:

In principle, an initial rough analysis of the network traffic (telegram analysis) is also possible via a mirror port on the switch using analysis software (e.g. Wireshark). However, this port only delivers 100 Mbps.

But the cable carries incoming data to the controller at 100 Mbps on one wire pair and outgoing data from the controller at 100 Mbps on the other wire pair. Thus the port of the switch cannot diagnose more than one half of the data flow.

Source: PI Design Guideline (V 1.38/Sep. 19) pp. 92-93

RECOMMENDATION – Quality values

Recommendations on the quality values in PROFINET by Indu-Sol

Jitter (deviation from the planned update time)	≤ 50 %
Telegram gap (missing telegram)	0
Error telegram (defective telegrams)	0
Load ratio (How heavily the network is loaded?)	100 : 1
Netload (in 100 Mbps)	< 20 %

Network planning software PROnetplan V2

The PROnetplan V2 software supports the user with the planning of Ethernet based networks, like e.g. PROFINET. PROnetplan does not only allow a rough planning of the network, but also a detailed planning

including port assignment, support for correct switch selection and transmission speeds. Due to the integrated diagnostic mode, which evaluates the network based on the PROFINET guidelines, incorrect planning of the network is hardly possible and subsequent changes are a thing of the past.

With PROnetplan V2 the user has the possibility to integrate his planned applications like PROFINET, but also camera monitoring and SCADA systems into the network in order to estimate which infrastructure components are necessary in order to integrate all applications in the best possible way. In addition to the bandwidth of the network, the port utilization and the respective transmission media are evaluated.

In the diagnostic mode, the IP addresses of the network devices are checked for correctness and address duplication. The topology created with PROnetplan V2 can be used for network optimization, as a discussion platform with the client as well as a document for a network installation.



Abb. 12: Network displayed in PROnetplan V2



PRONetplan

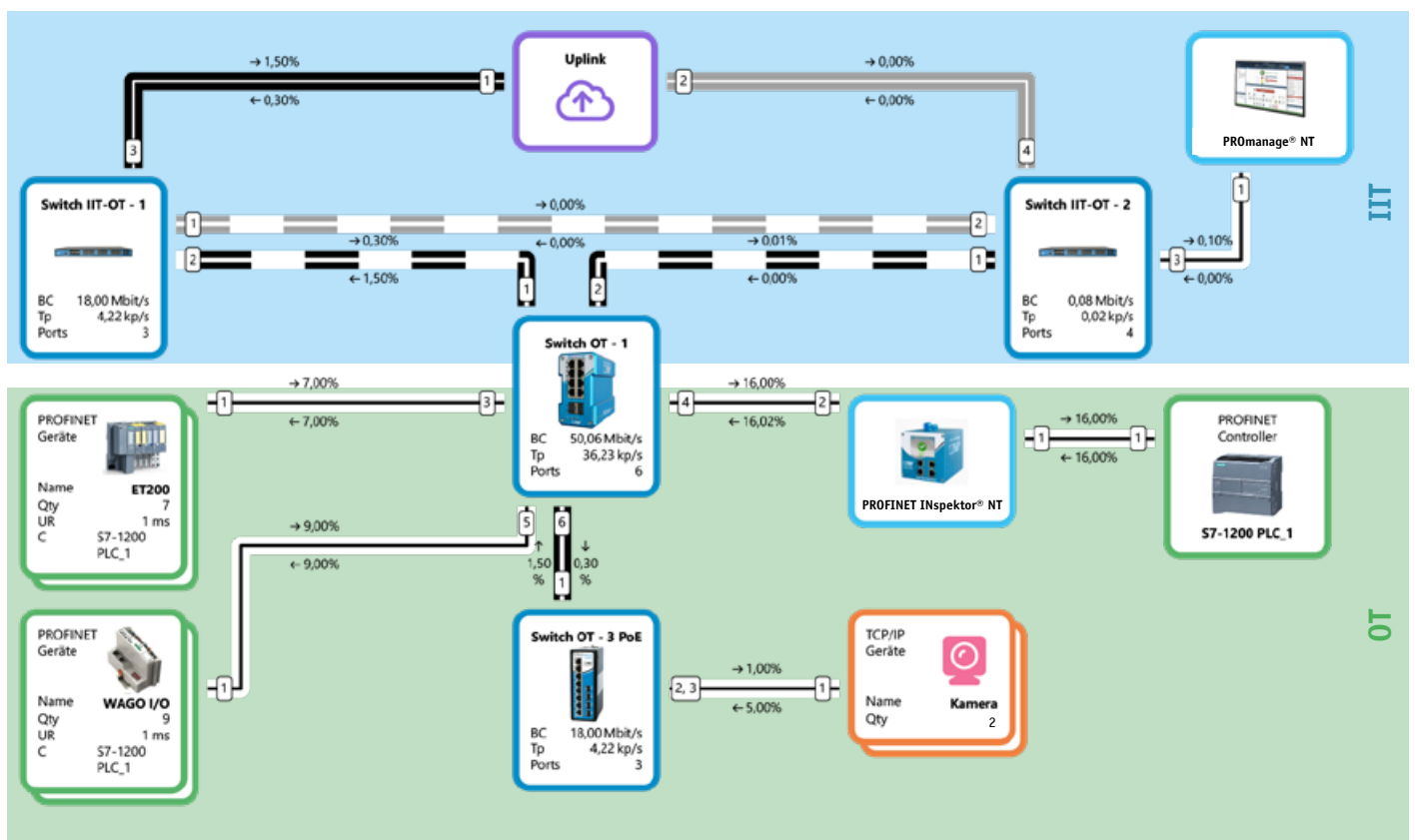
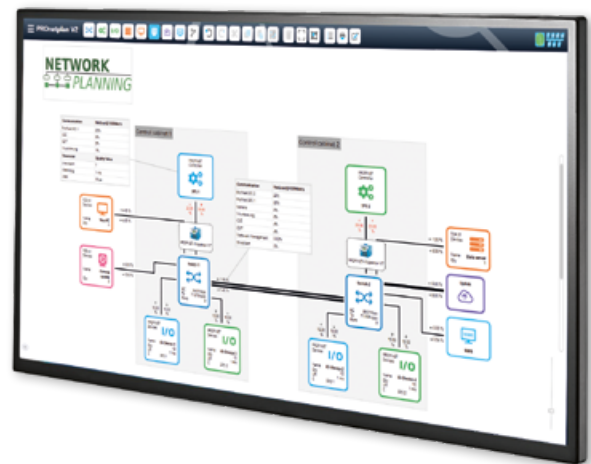
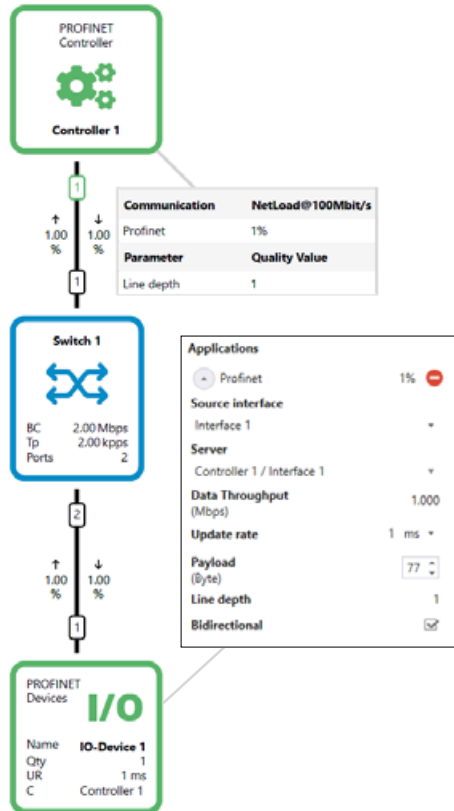

Netload

PRONetplan V2 shows dynamically for each connection in the network the resulting load. This also applies to complicated structures and to several controllers as well as arrangement to the IT level.

Line depth

To display the line depth, the PROFINET communication relationship between the controller and the assigned I/O device is always determined with the most device transitions.

Backplane capacity and data throughput

To select the appropriate switch, the necessary performance is dynamically and displayed directly in the network.

Update rate and payload

The update rate and payload can be set individually for each device, but also uniformly for device groups.

Diagnostic mode

By means of the diagnostic mode PRONetplan V2 evaluates briefly the created network and gives first hints what should be changed.



Diagnosis

Current State

4 Errors

✓	Netload	16,02 %	
✗	Line depth		2 Errors ▶
✗	IP address		2 Errors ▼
	network device	IP address	Diagnosis
	ET200	192.168.10.12	duplication
	WAGO I/O	192.168.10.12	duplication
✓	Port properties		

Highlights

- Planning according to PI guideline
- Individual application planning (e.g. PROFINET, SCADA and monitoring)
- Planning from machine to company network (OT, IIT, IT)
- Calculation of network load for each connection
- Calculation of switch performance parameters
- Port planning

PRONetplan in conjunction with PROscan® Active V2

The topologies scanned with the PROscan® Active V2 analysis software (see page 13) can easily be fed into PRONetplan.

This enables a comparison between the plan and reality. This procedure is very useful during planning an expansion or optimization of the network.



ETHERtest V5 and PROlinetest cable tester

Certification and acceptance

The **ETHERtest V5 (V5.1/V5.3)** cable tester provides for all measurements required for the acceptance and certification of network cables up to Class FA/Category 6A (1000 MHz). Not only line length but also attenuation, resistance, crosstalk (NEXT), delays, shielding and the proper contacts (connection schematic) are measured and evaluated. Beyond the certification of copper cables, attenuation and OTDR can be measured for single and multi-mode fiber optic cables by means of additional adapters (**ETHERtest V5.1**).

All recorded values are displayed graphically, which enables the error sources to be identified and localized with an accuracy of 10 centimeters. All measurements are stored automatically in the device and can be retrieved as measurement report using PC software.

Verification and troubleshooting

PROlinetest is an indispensable tool for all those who install or troubleshoot PROFINET systems. The device detects any wiring errors and tests the wires and wire pairs for continuity, breaks, short-circuits, cross-wiring and exceeded maximum cable lengths.

The measurement of the total cable length and the distance to the error location significantly simplifies troubleshooting. The adapter can also be used to check Drive-Cliq and M8/M12 cable systems.

Source: PI Commissioning Guideline (V 1.44/Sep. 19) pp. 47-62



Fig. 13: ETHERtest V5



Fig. 14: PROlinetest

RECOMMENDATIONS – Evaluation based on cable length

Compliance with the limits set out, for example, ISO IEC 11801 Class D, is always evaluated over a maximum distance of 100 m by the measuring equipment, e.g. 24 dB insertion loss. This means that in case of shorter cables (e.g. 10 m), it is also only compliance with an insertion loss of 24 dB that is monitored, which means that weak spots are not detected in advance.

Cable length	Max. insertion loss acc. to class D for 100 MHz	Length-dependent min. insertion loss	Length-dependent recommended min. insertion loss
100 m	24 dB	0 dB	3 dB
50 m	24 dB	3 dB	6 dB
25 m	24 dB	6 dB	9 dB
12 m	24 dB	9 dB	12 dB
6 m	24 dB	12 dB	15 dB
3 m	24 dB	15 dB	18 dB
1,5 m	24 dB	18 dB	21 dB

The qualitative evaluation of **insertion loss (IL)** should be performed while taking the line length into account.

This is why all measuring equipment should be evaluated based on length in accordance with the tables below in regard to the reserve insertion loss and the near-end crosstalk. By assessing the reserve, this procedure is independent from the standards and limits that are used.

Cable length	Min. near-end crosstalk acc. to class D for 100 MHz	Length-dependent min. near-end crosstalk	Length-dependent recommended min. near-end crosstalk
100 m	27,7 dB	27,7 dB	30,7 dB
50 m	27,7 dB	30,7 dB	33,7 dB
25 m	27,7 dB	33,7 dB	36,7 dB
12 m	27,7 dB	36,7 dB	39,7 dB
6 m	27,7 dB	39,7 dB	42,7 dB
3 m	27,7 dB	42,7 dB	45,7 dB
1,5 m	27,7 dB	45,7 dB	48,7 dB

The qualitative evaluation of the **near-end crosstalk (NEXT)** should be performed while taking the line length into account.



PROscan® Active V2

PROscan® Active V2 acceptance test and validation software

Online analysis / topology scan

With the **PROscan® Active V2** software you can generate a detailed description of your PROFINET networks online during running production at any time. Thanks to PROFINET devices' integrated LLDP protocol (detection of neighborhood relationships) it is possible to generate a complete topology map including all designations and connections in an extremely short time, and thereby simultaneously perform an initial simple diagnosis (line interruptions, device failures etc.) during operation. Other strengths of this product include flexible options for integration into existing plants and a simple, intuitive user interface.

The software helps to efficiently organize a complex network and, if required, perform necessary maintenance in a timely and direct manner. Its low resource requirements enable **PROscan® Active V2** to be installed on any commonly available touch panel.

Source: PI Commissioning Guideline (V 1.44 / Sep. 19) pp. 91/92

Highlights

- Easy to use
- Diagnostics mode
 - Connection statistics
 - Version statistics
 - EMC statistics
- Acceptance report
- Asset Management
- Network / device information
 - Current port assignments
 - Port operating mode
 - Port speed
 - Device version / name
 - IP- / MAC addresses
 - Software / Hardware versions
 - Error telegrams
 - Rejected telegrams (discards)
- Suitable for PROFINET and Ethernet networks



➤ **Advanced printing and export functions (PDF)** ➤ **comprehensive documentation options**

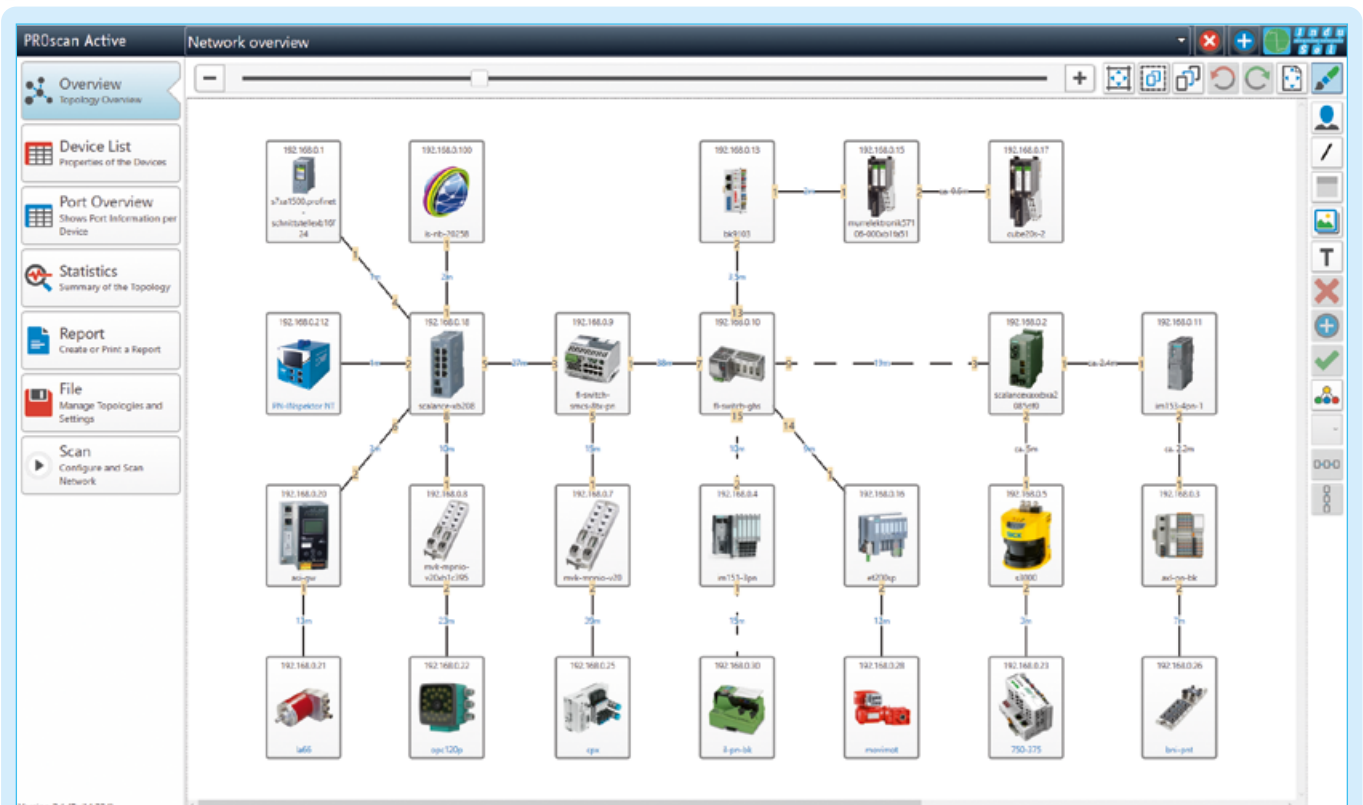

Fig. 15: PROscan® Active V2 - clear visualization of the network topology

PROscan® Active V2 acceptance test and validation software

Device list

In addition to the device information (manufacturer, ordering details), the automatically generated device list also gives a quick overview of the hardware and firmware versions of all devices used (including device extensions), allocating

the device names, IP and MAC addresses accordingly. The evaluation of this data can be exported into an acceptance-relevant log or for documentation as a CSV file at the push of a button.

Device List
Properties of the Devices

Actions	Device type	IP addresses	Subnet	Gateway	MAC address	Device name	HW version	SW version	Device type name	Order number	Controller name	RealTime Class	PROFINET Rolls
		172.20.1.51	255.255.255.0	172.20.1.51	00:1B:1B:72:7E:89	x208-cu-zeile4	6	V4.5.0	SCALANCE X-200	6GK5 208-0BA10-2AA3	controller-tafel	RTClass2	Device
		172.20.1.54	255.255.255.0	172.20.1.54	00:A0:45:68:20:F9	phoenix-switch-zeile3	5	V3.80.0	FL SWITCH SMCS 8TX-PN	2989103	controller-tafel	RTClass2	Device
		172.20.1.55	255.255.255.0	172.20.1.55	00:1B:1B:34:83:A6	x202-pof-zeile2	5	V5.0.22	SCALANCE X-200	6GK5 202-2BH00-2BA3	controller-tafel	RTClass2	Device
		172.20.1.56	255.255.255.0	172.20.1.56	00:1B:1B:1E:1B:21	et200s-pn-pof-zeile3	2	V7.0.1	IM151-3	6ES7 151-3BB23-0AB0	controller-tafel	RTClass2	Device
		172.20.1.58	255.255.255.0	172.20.1.58	00:0E:8C:D7:E3:32	x208-cu-zeile1	4	V4.5.1	SCALANCE X-200	6GK5 208-0BA10-2AA3	controller-tafel	RTClass2	Device
		172.20.1.59	255.255.255.0	172.20.1.59	00:1B:1B:24:DA:80	et200m-pn-zeile1	2	V4.0.0	IM153-4	6ES7 153-4AA01-0XB0	controller-tafel	RTClass2	Device
		172.20.1.60	255.255.255.0	172.20.1.60	00:1B:1B:3A:EC:7E	x208-cu-zeile5	6	V4.5.1	SCALANCE X-200	6GK5 208-0BA10-2AA3	controller-tafel	RTClass2	Device
		172.20.1.64	255.255.255.0	0.0.0.0	00:80:63:66:54:B0	octopus-zeile7	130	V4.2.3	Hirschmann OCTOPUS	6GK5 208-0BA10-2AA3	controller-tafel	RTClass2	Device
		172.20.1.65	255.255.255.0	172.20.1.65	00:16:77:00:8FA1	pn-asi-gw-zeile5	2	V2.0.0	AS-i	BWU1912	controller-tafel	RTClass2	Device

Slot	Subslot	Modul ID	Submodul ID	Vendor-ID	Order number	Serial number	HW version	SW version
1	1	0x00016001	0x00000000	42	6ES7 155-5AA00-0AC0	S C-HONX24052016	2	V3.0.1
2	1	0x00006D20	0x00000003	42	6ES7 521-1BH00-0AB0	S C-HDMX36262016	3	V2.1.2
3	1	0x00006D18	0x00000003	42	6ES7 522-1BH01-0AB0	S C-HDNK33432016	1	V1.0.0

		172.20.1.71	255.255.255.0	172.20.1.71	00:90:E8:3D:1D:BD	eds-510e	100	V4.0.0	MOXA EtherDevice Switch	0054-000510-E000	controller-tafel	RTClass2	Device
		172.20.1.74	255.255.255.0	172.20.1.74	00:01:05:16:EE:87	bk9103			BK Device				Device

Port overview

In addition to the device list with all device-relevant data, a list of port relevant data for each device is also available. The overview shows both the cable lengths of copper and polymer fiber connections as well as the attenuation reserve of polymer fiber connections.

Information on error telegrams or rejected telegram packets (CRC error or discards) is important for detecting weaknesses and to perform an error analysis.

Port Overview
Shows Port Information per Device

Number	Name	Connected with	Line type	Length	Send power budget	Remote power budget	Connection	InDiscards	OutDiscards
172.20.1.200 (controller-tafel)									
2	port-002	172.20.1.55 (x202-pof-zeile2)	Copper	ca. 58,6m			100BaseTXFD	0	78
172.20.1.54 (phoenix-switch-zeile3)									
1	port-001	172.20.1.60 (x208-cu-zeile5)	Copper	17,2m			100BaseTXFD	0	0
2	port-002	172.20.1.51 (x208-cu-zeile4)	Copper	47,1m			100BaseTXFD	0	0
3	port-003	172.20.1.248 (inblox)	Copper	5,0m			100BaseTXFD	0	0
4	port-004	172.20.1.82 (ASi-INSpektor)	Copper	5,0m			100BaseTXFD	0	0
5	port-005	172.20.1.81 („PB-INSpektor V2“)	Copper	5,0m			100BaseTXFD	0	0
172.20.1.55 (x202-pof-zeile2)									
1	port-001	172.20.1.200 (controller-tafel)	Copper	ca. 58,6m			100BaseTXFD	0	0
2	port-002	172.20.1.71 (eds-510e)	Copper	10,5m			100BaseTXFD	0	0
3	port-003	172.20.1.56 (et200s-pn-pof-zeile3)	Fibre-optic Cable	20,5m	4,2 dB	10,8 dB	100BaseTXFD	0	0
172.20.1.56 (et200s-pn-pof-zeile3)									
1	port-001	172.20.1.55 (x202-pof-zeile2)	Fibre-optic Cable	20,5m	10,8 dB	4,2 dB	100BaseTXFD	0	0



PROscan® Active V2

Explanations (Discards/Error telegrams)

Data packets may be discarded by the switch, e.g. because of malfunctions, transmission errors or queue overflow at the switches.

PROscan® Active V2 determines the number of such discards (rejected telegram packets) and the number of defective telegrams (CRC errors) from the devices and displays them in a table. This provides clues as to potential causes of error.

During the analysis of such information special attention needs to be paid to devices in communication lines with high load, e.g. switches of the primary infrastructure. (see Fig. 16)

Source: PI Commissioning Guideline (V 1.44 / Sep. 19) pp. 93/94

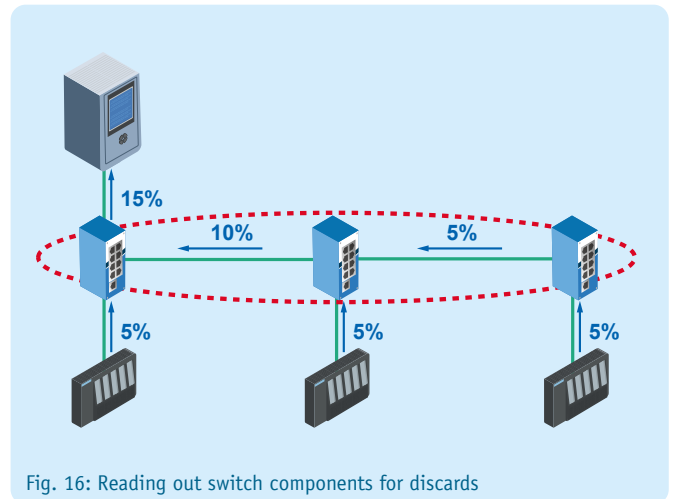



Fig. 16: Reading out switch components for discards

Checking the system reserve for optical cabling

If using polymer optical fiber (POF), the optical system reserve (power budget) of every single connection can be determined in online operation. It is a measure for the available optical power reserve between transmitter and receiver to ensure trouble-free operation. It can be read out and displayed as a diagnostic value. If the attenuation reserve of a POF connection falls below 5 dB, it is immediately apparent where transmission problems might occur.

These are represented by an exclamation mark  in the connection. This enables you to detect and remedy the weaknesses in your system at any time.

Source: PI Commissioning Guideline (V 1.44 / Sep. 19) pp. 88/89

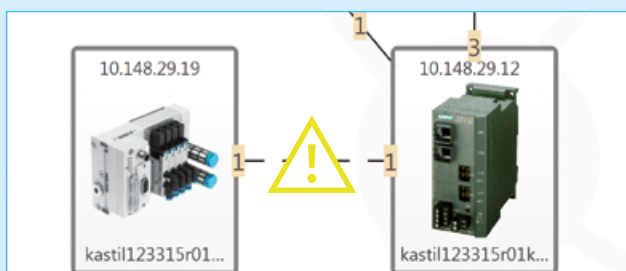

Fig. 17: Display when transmission problems occur

System reserve	Evaluation
> 6 dB	The value is above the measurement range. No action required.
> 2 dB to 6 dB	The value is within the valid measurement range. Trouble-free communication is ensured. Typical values for cabling without other plug-in connections: <ul style="list-style-type: none"> • 5 dB for cable lengths up to 30 m • 3,5 dB for cable lengths from 30 m to 40 m • 2,5 dB for cable lengths from 40 m to 50 m In case of deviation from the listed value ranges a cable inspection is recommended (check for additional plug-in connections, attenuation check).



PROscan® Active V2

PROscan® Active V2 acceptance test and validation software

Diagnostics mode

An overview immediately shows the user all anomalies detected by the network scan. In the connection statistics, for example, device ports are listed with accumulated discards or error telegrams as well as a too low optical fibre system reserve. Additionally, a statistic of the software and hardware statuses of all devices (including device extensions) quickly reveals whether there are discrepancies between devices of the same type.

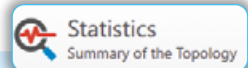

Main modules	Order number	SW Version	HW Version	Num. of devices
AXL BK PN-ME	2688132	V1.2.0	5	1
BNI PNT-502-102-Z015	BNI006C	V2.2.0 V2.3.0	5 5	1
Cube20S	57106	V1.3.6	1	1
ET200SP	6ES7 155-6AU00-0CNO	V3.1.0	4	1
FL SWITCH GHS 4G/12	2700271	V2.62.0	6	1
FL SWITCH SMCS 8TX-PN	2989103	V4.40.0	5	1
FTS3100-A	20781104000	V2.2.2	256	1
Helmholz PN-Switch	700-850-4PS01		0	1
IM151-3	6ES7 151-3BB23-0AB0	V7.0.5	3	1
IM153-4	6ES7 153-4AA01-0XB0	V4.0.0	2	1
PN-Inspektor NT	124030100			1
PROscanActive	117000014	2.0.0.218		1
S7-300	GES7 318-3FL01-0AB0	V3.2.6	5	1
SCALANCE X-200	6GK5 208-0BA10-2AA3	V5.1.0 V5.1.3	6 6	1
SICK-S3000PROFIsafe	1064234	V1.11.0	0	1
WAGI-Io-SYSTEM 75x	750-370	V2.5.10	4	1
wenglor ident	weQube	V1.1.4	100	1

Fig. 18: Version statistics

IP-Address	Device	Port	Value
Connections/Ports with IN DISCARDS			
10.1.9.5	fl-switch-ghs	port-001-00009	2
10.1.9.6	bk9103-1-1	port-001	4
10.1.9.6	bk9103-1-1	port-002	164
10.1.9.18	bnipnt502102z015-1	port-001	187206
10.1.9.18	bnipnt502102z015-1	port-002	383429
10.1.9.19	bnipnt502102z015	port-002	427308
10.1.9.21	wenglor-cam	port-001	2
10.1.9.94	iPNMA	Pa????	6
10.1.9.96	profinet-inspektor-nt	port-passive	4
10.1.9.97	PN-InspektorNT5	port-passive	17
Connections/Ports with IN ERRORS			
10.1.9.2	pn-io	port-002	869365
10.1.9.3	scalance-x208	port-003	874391
10.1.9.3	scalance-x208	port-005	949
10.1.9.3	scalance-x208	port-006	21172
10.1.9.4	fl-switch-smcs-8tx-pn	port-001	23
10.1.9.5	fl-switch-ghs	port-001-00009	4
10.1.9.15	im153-4pn-1	port-002	1
10.1.9.17	helmholz-pn-switch	port-001	1
10.1.9.17	helmholz-pn-switch	port-004	1
10.1.9.18	bnipnt502102z015-1	port-001	1189
10.1.9.21	wenglor-cam	port-001	3
10.1.9.62	mobmesse-x208	port-004	59
10.1.9.96	profinet-inspektor-nt	port-passive	17
10.1.9.97	PN-InspektorNT5	port-passive	22
Connections with too low attenuation reserve			
10.1.9.9	im151-3pn	port-001	16,4
Connections/Ports with OUT DISCARDS			
10.1.9.17	helmholz-pn-switch	port-001	60
10.1.9.17	helmholz-pn-switch	port-003	49
10.1.9.17	helmholz-pn-switch	port-004	330474
10.1.9.21	wenglor-cam	port-001	5
Connections/Ports with OUT ERRORS			
10.1.9.21	wenglor-cam	port-001	6

Fig. 19: Connection statistics

Acceptance log

PROscan® Active V2 is able to create a complete acceptance log with only a few clicks.

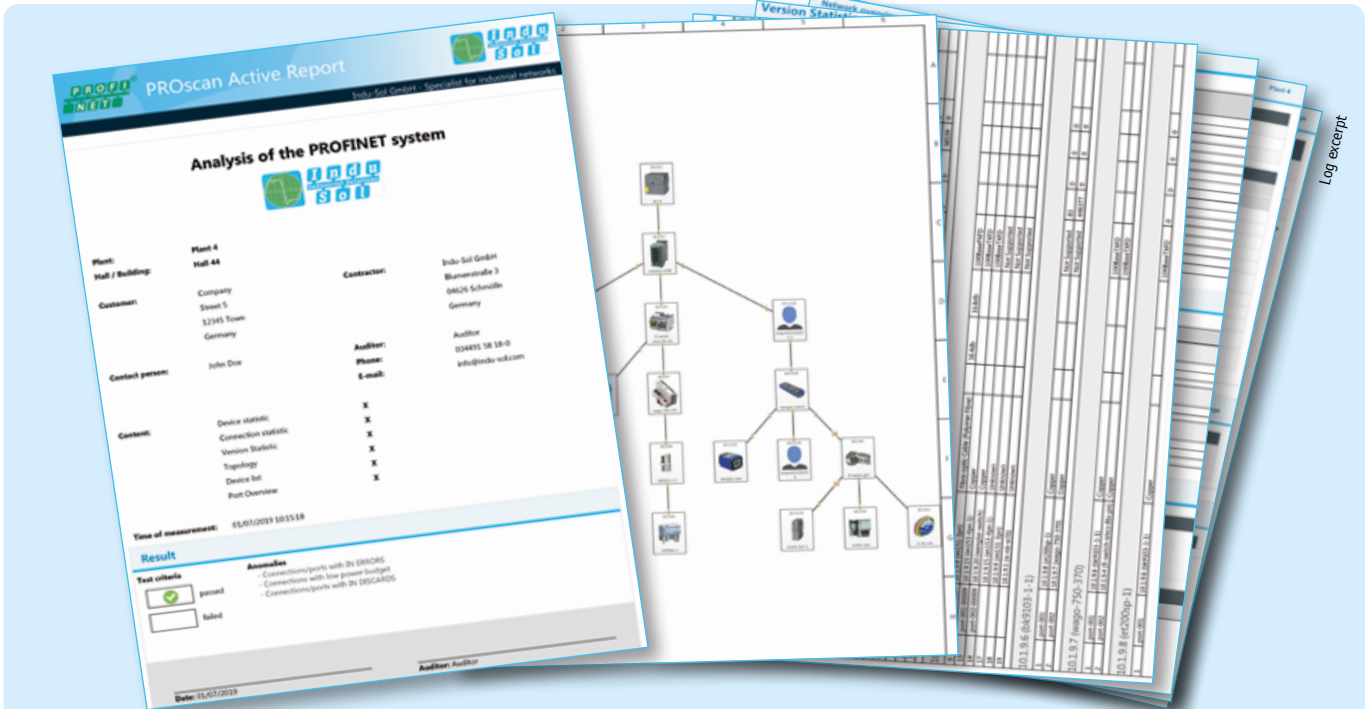

Fig. 20: Clear overview of all important information – this includes all system information (e.g. records of EMC conditions in the bus environment)



PROFINET-INspektor® 1G analysis and diagnostic tool

The **PROFINET-INspektor® NT** is an intelligent, passive measurement and diagnostic tool for temporary or permanent monitoring of PROFINET networks. Due to its passive and feedback-free behavior it is highly suitable for online analysis.

The **PROFINET-INspektor® NT** is both a full-featured measuring device for network acceptance and a tool for condition monitoring.

Network parameters – Quality parameters

User-friendly display of network conditions with traffic light colors and time graphs enable any user to respond quickly in an emergency and ensure a good general overview.

All subsequently listed quality parameters are detected as events, evaluated, cached and displayed in a clear overview.

Highlights

- Ease of use, well-structured handling
- Automated evaluation through traffic light function
- Passive, feedback-free diagnostics
- Cyclical topology detection
- OPC UA Server



- Alarms in case of unknown devices
- Network anomaly detection
- Detection of programming accesses to the PLC

- Telegram gaps
- Telegram jitter
- Telegram overtakes
- Error telegrams
- Update times
- Network load
- Load ratio
- Device diagnoses
- Device failures
- Device restarts

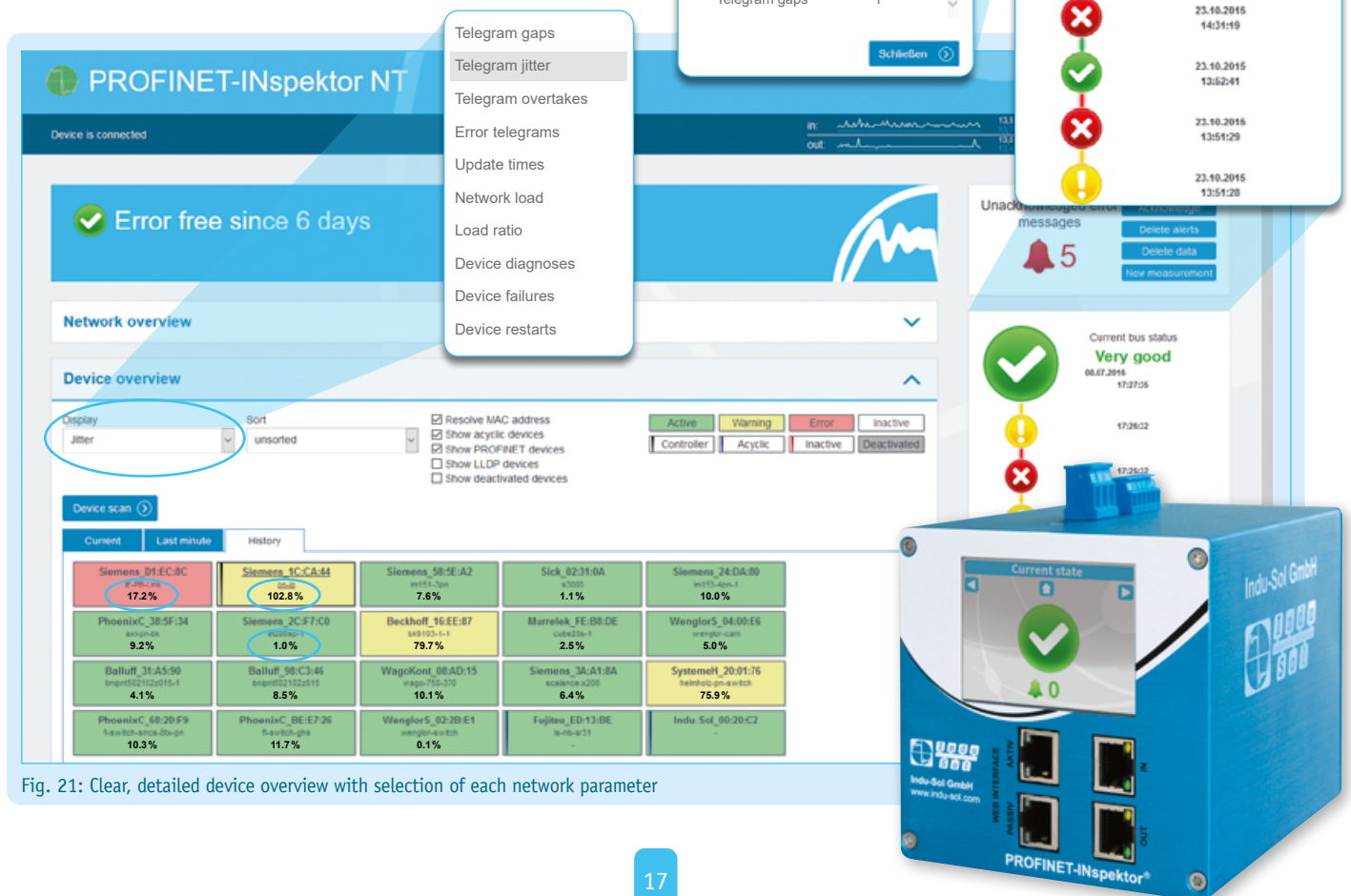

The screenshot displays the main interface of the PROFINET-INspektor NT software. At the top, it shows 'Device is connected' and a status 'Error free since 6 days'. Below this is a 'Network overview' section with a dropdown menu listing parameters: Telegram gaps, Telegram jitter, Telegram overtakes, Error telegrams, Update times, Network load, Load ratio, Device diagnoses, Device failures, and Device restarts. The 'Device overview' section shows a table of devices with their current status and jitter percentages. A 'Device scan' button is visible. On the right, there are panels for 'Current bus status' (Very good) and 'Unacknowledged messages' (5). A physical device is shown at the bottom right, displaying its current state on a screen.

Device	MAC Address	Current Status	Jitter (%)
Siemens_D1:EC:8C	48151-30n	Active	17.2%
Siemens_1C:CA:44	48151-30n	Warning	102.8%
Siemens_5B:FE:A2	48151-30n	Active	7.6%
Sick_02:31:0A	48151-30n	Active	1.1%
Siemens_24:DA:00	48151-30n-1	Active	10.0%
PhoenixC_38:5F:34	48151-30n	Active	9.2%
Siemens_2C:F7:C0	48151-30n	Active	1.0%
Beckhoff_16:EE:87	48151-30n-1	Active	79.7%
Murrelek_FE:B8:DE	48151-30n	Active	2.5%
Wenglor_04:00:E6	48151-30n	Active	5.0%
Balluff_31:A5:90	48151-30n-1	Active	4.1%
Balluff_90:C3:46	48151-30n	Active	8.5%
WagoKont_08:AD:15	48151-30n	Active	10.1%
Siemens_3A:A1:8A	48151-30n	Active	6.4%
SystemeH_20:01:76	48151-30n	Active	75.0%
PhoenixC_68:20:F9	48151-30n	Active	10.3%
PhoenixC_BE:E7:26	48151-30n	Active	11.7%
Wenglor_02:2B:E1	48151-30n	Active	0.1%
Fujitsu_ED:13:BE	48151-30n	Active	-
InduSol_00:20:C2	48151-30n	Active	-

Fig. 21: Clear, detailed device overview with selection of each network parameter

PROFINET-INspektor® 1G analysis and diagnostic tool

Device information

	Last minute			History		
MAC address	PhoenixC_38 5F 34					
IP address	10.1.9.10					
Name	axl-pn-bk					
Alias						
Vendor	AXL BK PN-ME					
Vendor ID	Phoenix Contact GmbH & Co. KG (176)					
Device ID	4096					
Device role	Device					
Alert (low priority)	✓	0		✓	0	
Alert (high priority)	✓	0		✓	0	
Failures	✓	0		✓	0	
Restarts	✓	0		✓	0	
Frame gaps	✓	0		✓	0	
Concurrent frame gaps	✓	0		✓	0	
Frame overtakes	✓	0		✓	0	
Error frames	✓	0		✓	0	
Jitter	✓	8.4%		!	122.0%	
Update rate	min	avg	max	min	avg	max
Measured update rate	0.23ms	0.25ms	0.27ms	0.01ms	0.25ms	0.56ms
Payload (sent)	174.90 B	176.00 B	177.14 B	108.72 B	176.00 B	226.69 B
Payload (received)	174.90 B	176.00 B	177.14 B	108.72 B	176.00 B	226.64 B
Netload (sent per sec)	2.16%	2.18%	2.19%	1.34%	2.18%	2.80%
	270.30 kB	272.00 kB	273.77 kB	168.10 kB	272.00 kB	350.27 kB
Netload (received per sec)	✓ 2.16%	✓ 2.18%	✓ 2.19%	✓ 1.34%	✓ 2.18%	✓ 2.80%
	270.30 kB	272.01 kB	273.77 kB	168.03 kB	272.01 kB	350.34 kB

Network statistics

	Last minute	History
Load ratio	>500 : 1	>500 : 1
Broadcasts (of these PROFINET)	0 (0 0%)	0 (0 0%)
Multicasts (of these PROFINET)	0 (0 0%)	0 (0 0%)
Frames (sent) (of these PROFINET)	239.997 (239.999 100.00%)	100.176.240 (100.176.132 100.00%)
Frames (received) (of these PROFINET)	240.000 (240.000 100.00%)	100.177.025 (100.176.916 100.00%)

Topology determination

The **PROFINET-INspektor® NT** not only determines all relevant device information (device details and port statistics), but even the real wiring (topology). This can also be done remotely without having to establish a direct network access via a service computer or HMI. The scan can easily be started and saved remotely or by using the integrated web-server of the **INspektor®** from the own company network.

The determined topology can then be conveniently opened and evaluated on your own computer using the software **PROscan® Active V2** (see page 13). In addition to manual topology determination, there is the option to set up a regular scan in order to detect changes in the network structure and the devices integrated into the network in good time and to document these in a trackable form. These topologies are recorded

Netload visualization (see Fig. 22)

While other diagnostic devices determine the network load by the second or even the minute, the **PROFINET-INspektor® NT** measures netload by the millisecond and displays it. This makes even minimal load changes in a network detectable. Even in the millisecond range peak loads may cause significant disturbances in the network which would not be detectable without this analysis.

Such short-term peak loads may be caused, e.g. by erroneous hardware settings or active diagnostic tools that continuously send queries into the network.

The network should always be monitored for a consistent netload and any sources of disturbances should be removed. Continuous, passive analysis as provided by the **PROFINET-INspektor® NT** is an indispensable prerequisite.

Please note:

According to the current certification guideline PROFINET devices are tested and specified with a maximum load per millisecond between 1 and 10%, depending on the netload class.

Source: PROFINET I/O Security Level 1 (Netload) – Version 1.2.1.1 – February 2017

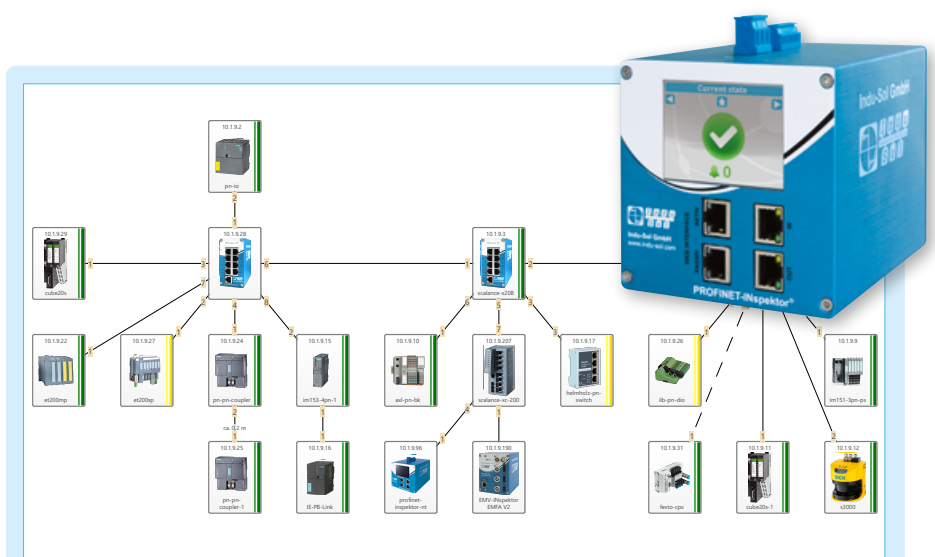

Fig. 22: Topology determination with the PROFINET-INspektor® 1G

centrally with the help of the software **PROmanage® NT** (see page 24) and remain accessible for a period of up to one year.



PN-INspektor[®] NT

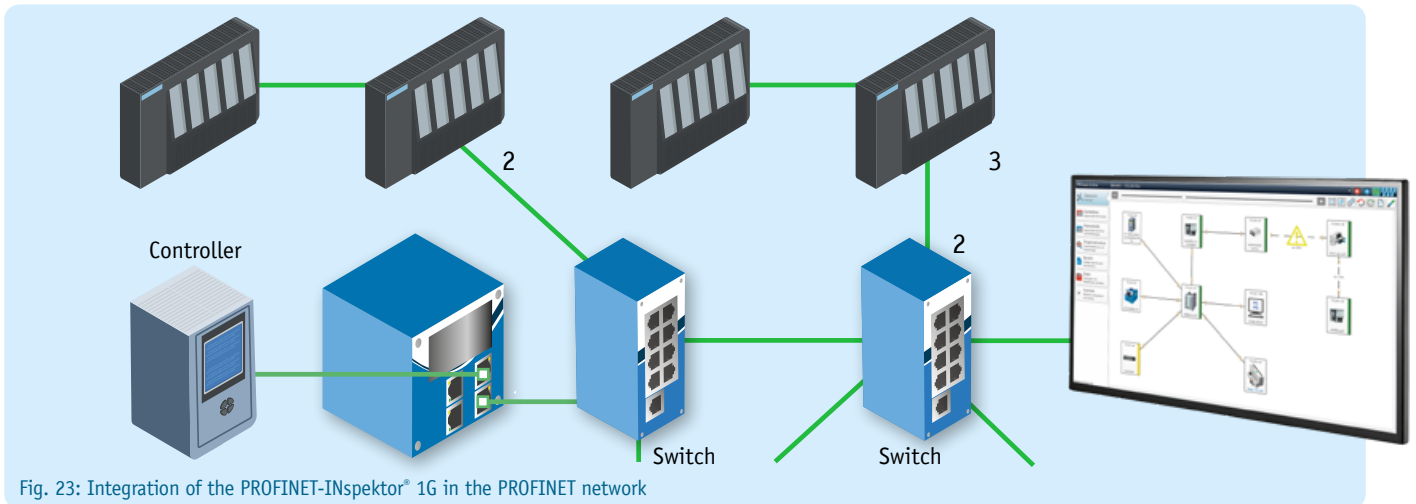

Fig. 23: Integration of the PROFINET-INspektor[®] 1G in the PROFINET network

Trigger function – Alarms

Trigger functions enable the setting of quality parameters for the network as a whole, but also individually for each device if required. In the event of changes that exceed the preset thresholds alarm messages (SNMP, OPC UA, email, web interface) are sent or displayed directly via a potential-free contact.

The **PROFINET-INspektor[®] NT** has an integrated web server and a freely selectable IP address. This enables a visualization of the network condition by means of an Internet browser on any PC, on site or remotely.

In addition to each alarm message telegram copies are stored on the **INspektor[®]** and can be downloaded via the web interface for a more detailed error evaluation.

Type	Device	Event	Date
Status change	00:01:05:16:EE:87	Jitter	26.10.2019 17:49:59.316
Status change	28:63:36:2C:F7:C0 192.168.0.6	Bus node failure	23.10.2019 14:32:20.171
Status change	28:63:36:05:B1:B8 192.168.0.1	Telegram gaps	23.10.2019 14:31:21.983
Status change	28:63:36:2C:F7:C0 192.168.0.6	Bus node failure	23.10.2019 14:31:18.777
Status change	28:63:36:2C:F7:C0 192.168.0.6	Telegram gaps	23.10.2019 13:52:41.164
Status change	28:63:36:85:B1:B8 192.168.0.1	Telegram gaps	23.10.2019 13:51:32.572
Status change	28:63:36:2C:F7:C0 192.168.0.6	Bus node failure	23.10.2019 13:51:27.861
Status change	28:63:36:2C:F7:C0 192.168.0.6	Alert (low)	23.10.2019 13:51:27.665

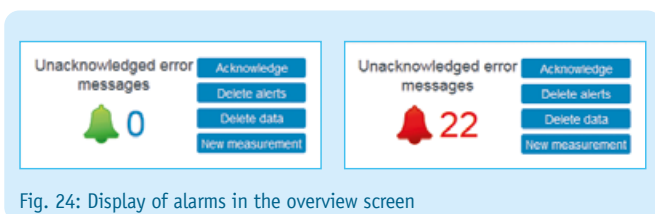

Fig. 24: Display of alarms in the overview screen

User-friendly display of network conditions with traffic light colors and time graphs enable any user to respond quickly in an emergency and ensure a good general overview.

RECOMMENDATION – Quality values

Recommendations on the quality values in PROFINET by **Indu-Sol**

Jitter (deviation from the planned update time)	≤ 50 %
Telegram gap (missing telegram)	0
Error telegram (defective telegrams)	0
Load ratio (How heavily the network is loaded?)	100 : 1
Netload (in 100 Mbps)	< 20 %



PN-INSPEKTOR NT

PROFINET-INSPEKTOR® 1G analysis and diagnostic tool

Touchscreen

The display serves primarily to show the current status of the network and the accumulated faults. This information makes it possible, without an additional computer, to make an assessment about the status of the network.

Much important system information of the PROFINET-INSPEKTOR® NT is displayed as well. Thus the network

settings are needed to connect to the web interface and to view further detail information. Notes on firmware and hardware versions can be accessed via the display as well.

Navigation between the individual windows is done by touch control via the arrow buttons.



Acceptance log

Just like with PROscan® Active V2, the PROFINET-INSPEKTOR® NT provides the option to have a comprehensive acceptance log generated with just a few clicks.



Fig. 25: Clear overview of all important information – this includes all system information (e.g. records of EMC conditions in the bus environment)

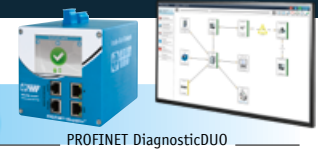

PROFINET DiagnosticDUO (PROscan® Active V2 & PROFINET-INspektor® NT)

Combined, the **PROscan® Active V2** software and the passive data collector **PROFINET-INspektor® NT** form the perfect navigation system for your network: the **PROFINET DiagnosticDUO**.

Thanks to the teamwork between a live topology map and a diagnostic display the position of each device can be found immediately and its "health status" can be assessed. This enables you to respond promptly and directly to any irregularities. Intuitive traffic-light colors provide a network analysis at a glance.

Highlights

- First user-friendly topological visualization of in-depth network analysis
- Continuous analysis of the communication quality (network load, telegram gaps, jitter etc.)
- Device status is indicated graphically with traffic-light colors in the topology
- Retrieval of current device list (PROFINET name, IP/MAC address, hardware/software versions, device types etc.)



PROFINET DiagnosticDUO

Interaction of diagnosis and topology – PROFINET DiagnosticDUO

By activating the function "Read out **PROFINET-INspektor® NT**" in the **PROscan® Active V2** software, you can combine the recordings of both tools. This gives you a navigation system for your PROFINET network so you can see the status of all devices displayed graphically with traffic-light colours in the topology.

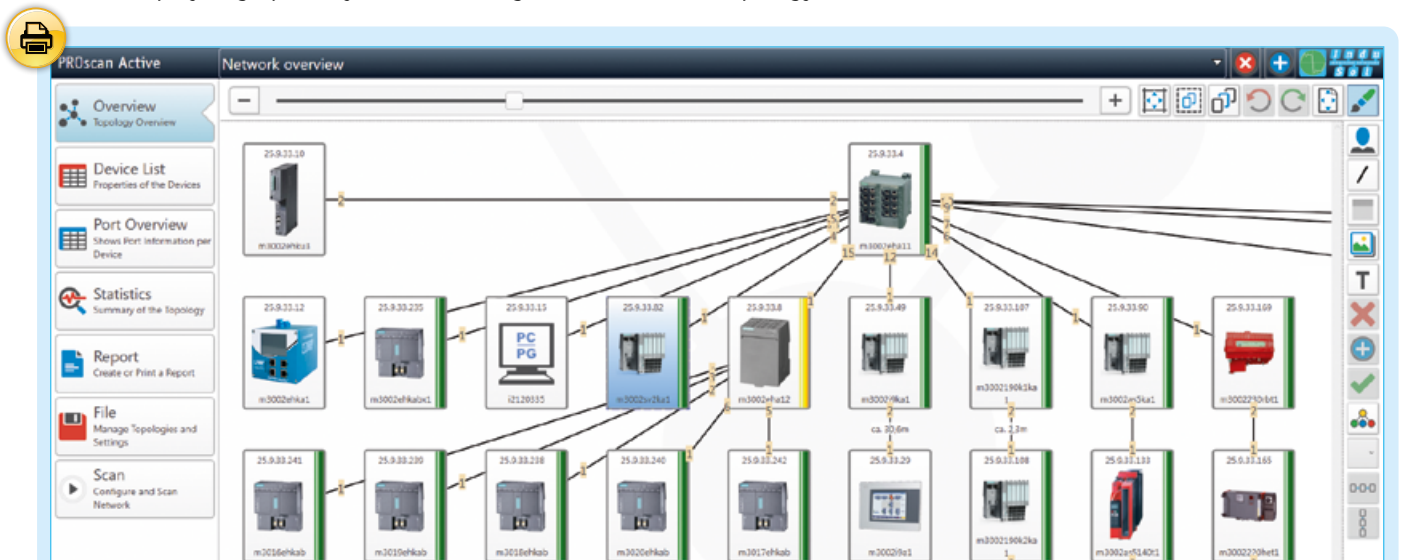

Fig. 26: Information from the topology with PROscan® Active in conjunction with the evaluated quality parameters of the PROFINET-INspektor® NT

EmCheck® LSMZ I leakage current measuring clamp

Ever more often, compensating currents caused by high-frequency shielding currents create intermittent faults in industrial data communication systems. On one hand, these currents may disturb the transmission itself. On the other, they may damage the devices by overloading. Because such effects of high shielding currents are only noticeable after a some time has passed, it is useful to define limits and document compliance even for new systems. Shielding currents during running operation should be lower than 40 mA.

RECOMMENDATION

Independently of the system specification, experiences at Indu-Sol show that shielding currents of < 40 mA can be tolerated. The decision of what is acceptable should always be made in the context of the frequency range in order to be able to perform suitable measures to reduce shielding currents.

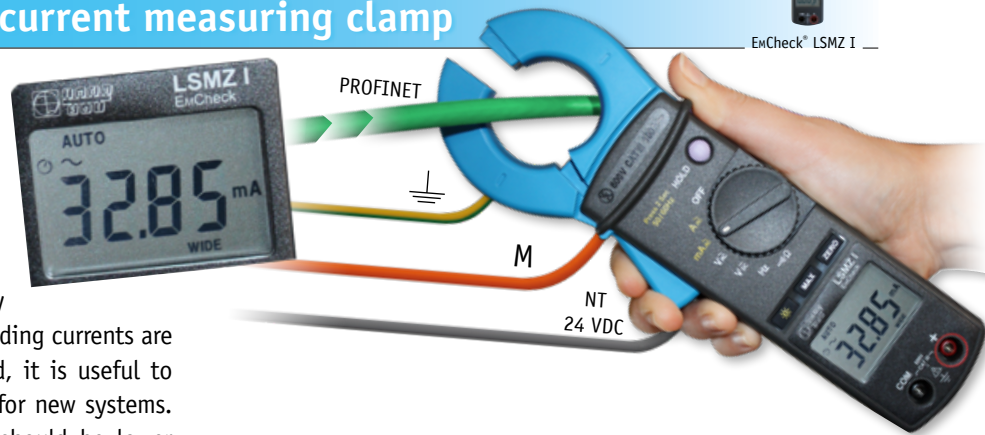

The **EmCheck® LSMZ I** leakage current clamp meter is designed specifically to measure leakage and shielding currents in the frequency range of 50/60 Hz or 5 Hz - 1 kHz. The adjustable measurement range can be set between 30 µA and 100 A. For measuring shielding currents on a data cable, the lower end of the range is more relevant. The **EmCheck® LSMZ I** leakage current clamp meter is also an ideal tool to find insulation faults and unplanned shutdowns caused by leakage currents and tripped FI switches. It also offers all the features of a multimeter clamp. To determine loop impedances, the **EmCheck® MWMZ II** loop impedance measurement clamp (see page 35) can be used.

PROFINET Diagnostic set



Highlights

- Online network diagnostics: **PROFINET-INspektor® NT**
- Topology software: **PROscan® Active V2**
- Network monitoring software: **PROmanage® NT**
- Leakage current measuring clamp: **EmCheck® LSMZ I**
- Cable diagnostics: **PROlinetest** or alternatively **ETHERtest V5.0** or **V5.3**

On request we will provide you with an instruction to the functions, benefits and uses of the complete contents of the **PROFINET Diagnostic set** (see page 34). This introduction is especially suitable for those in charge of commissioning, service and maintenance.

We will gladly provide a separate offer for individual devices (see page 33 ff.).



Intelligent PROFINET measuring point iPNMA

The intelligent PROFINET measuring point **iPNMA** combines the functions of a PROFINET measuring point with a simple PROFINET network analysis. The following quality parameters are determined:

- Telegram jitter
- Telegram gaps
- Telegram overtakes
- Network load
- Update rate
- Device diagnoses
- Device failures and restarts
- Error telegrams



In this case, the evaluation of the recorded data does not take place on the device itself, but instead all data is queried and processed by the **PROmanage® NT** software (see page 24) and processed accordingly.

In addition to the integrated diagnostics function, an analysis tool (e.g. **PROFINET-INSPEKTOR® NT** or laptop) can be connected completely reactionless to the two monitor jacks (monitor M1 and M2) for a more thorough network analysis or troubleshooting.

Highlights

- Monitoring all important PROFINET quality values
- Reactionless measurement point
- Compact design
- In case of a power supply failure, the PROFINET communication remains intact
- Power supply of additional analytic tools via the UOUT (24V DC) connector

General properties	PN-INSPEKTOR® NT	iPNMA
Passive network access (TAP)	×	×
24V supply for additional device (PN-INSPEKTOR® NT)		×
Number of monitored participants	512	256
Decoding of DCP/PROFINET parameters	×	×
Monitoring of non-PROFINET communication	×	
Evaluation of the recorded data		
PROmanage® NT	×	×
Touch display showing the network status and further information	×	
Webinterface	×	
Diagnostics mode with PROscan® Active V2	×	

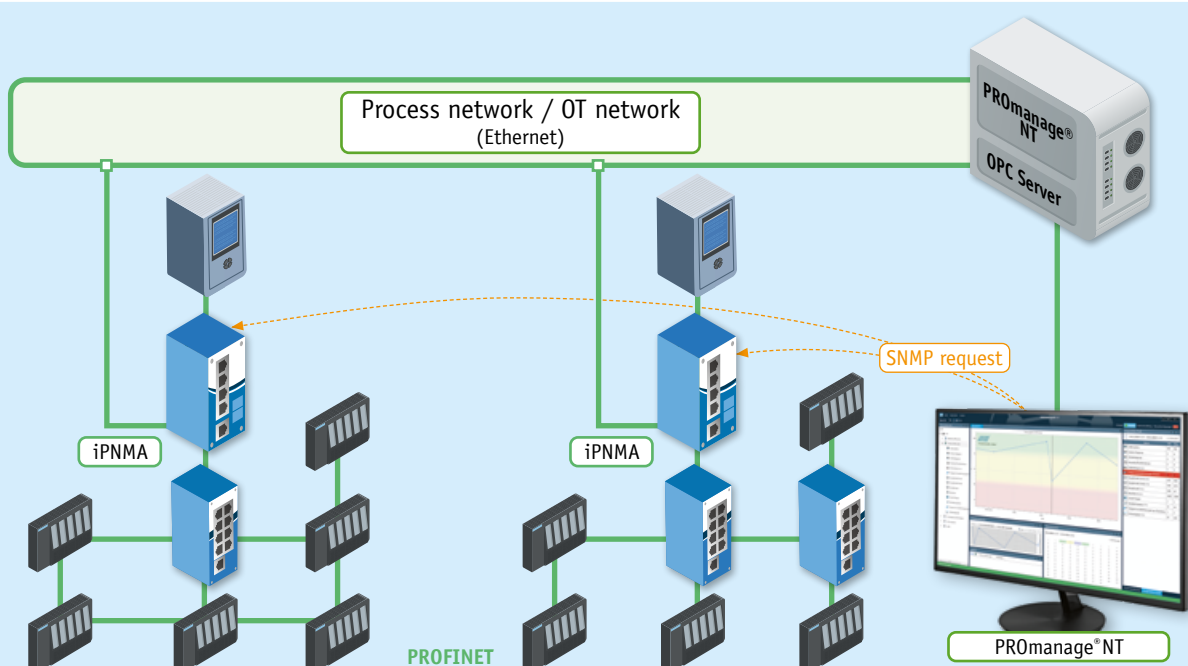

Fig. 27: Integration of the iPNMA measurement point in the PROFINET network and evaluation of the data via PROmanage® NT

PROmanage® NT network monitoring software

For preventative, condition-oriented maintenance of PROFINET networks **Indu-Sol** has developed a strategy for permanent network monitoring (referred to as PNM in the following). It provides for condition monitoring with the goal of **“warning before failure”**.

The concept of PNM provides for a continuous network analysis with a decentral, passive data collector, the **PROFINET-INspektor® NT**. Whenever preset threshold values are exceeded this event is stored together with a time stamp. The installation is between the controller and the first switch port. Each controller therefore requires an **INspektor®**.

With **PROmanage® NT** all external **INspektors®** are integrated in the monitoring via the existing Ethernet network, and the network conditions are bundled centrally on a server. The network-specific events are pre-processed by the **PROFINET-INspektor® NT** and provided chronologically by the **PROmanage® NT** network monitoring software for further processing and evaluation.

PROmanage® NT enables the evaluation, analysis and long-term storage of condition data for your fieldbuses and other industrial networks. For this purpose **PROmanage® NT** retrieves the port statistics of manageable switches and the events of the decentral data collectors (**INspektors®**), evaluates them and displays them graphically.

This sophisticated method of analysis makes irregularities immediately apparent. When a value exceeds or falls below a configurable threshold value an alarm activates. The statistic function keeps data exact to the minute available up to one year. This means historical events can be opened up for viewing at any time for cause analysis, e.g. of sporadic failures.

Highlights

- Central monitoring of all fieldbuses and networks
- Avoid system failures
- Timely warning via OPC, SNMP trap or email in case of irregularities
- Data exact to the minute available up to one year
- Quick installation
- Easy device set-up due to automatic and manual device scan

To improve system availability the following targets are set for a PNM system:

- Continuous monitoring of real communication
- Complete monitoring and detection of causes of network weaknesses
- Automatic alarms when negative developments occur
- Central overview of all networks





PROmanage® NT

Topology

The software **PROscan® Active V2** and/or a decentralised data collector such as the **PROFINET-INspektor® NT** determine the topologies of the individual networks. With the help of the software **PROmanage® NT**, these can be recorded at a central point, can be bundled, and therefore be displayed to the user in a clear manner, including all device information and statistics that were obtained.

This creates a permanent, up-to-date, and real overview over which devices are located where in the network and what their status is. This allows for the affected devices being located quickly in case of incidents in the network. If changes are made to the wiring of the network, the respective times can be determined through the continuous recording of the topology. The anomalies that can be detected in this manner include removed and newly added

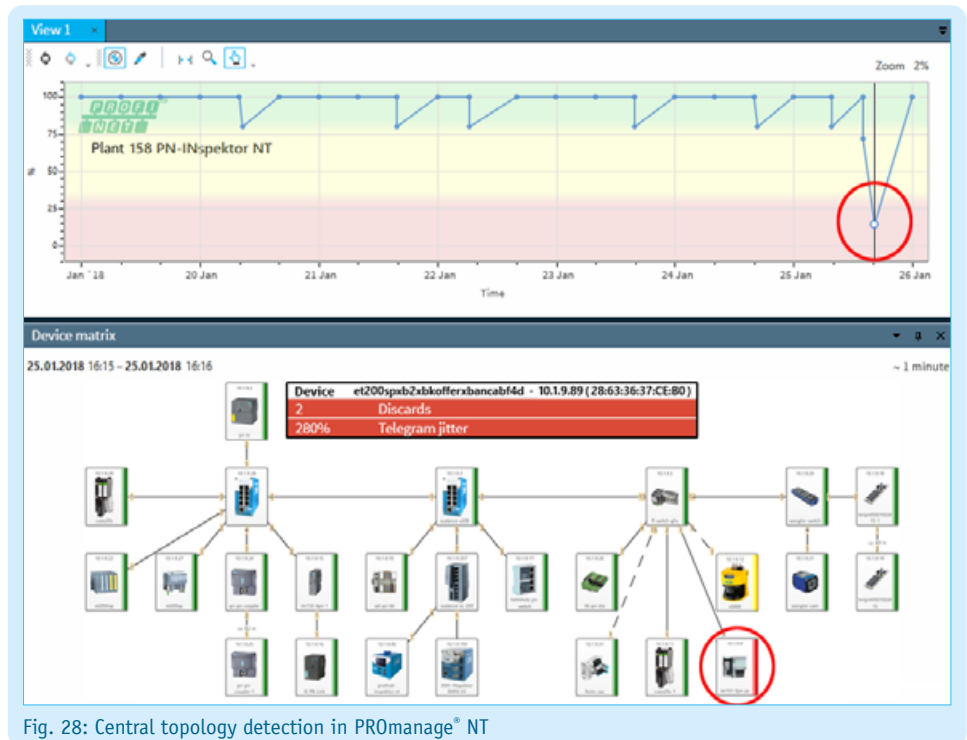

Fig. 28: Central topology detection in PROmanage® NT

devices as well as changes in port allocation of the switches in question.

Plant layout

In order to get a better overview of the real plant layout, individual devices in the topology can be allocated to individual system parts or installation locations for example, control cabinets, robots, etc. This allows for a comparison of the determined network structure with the real system

layout (see Figure 29). This function allows for the mapping of complete assembly lines or a complete floor plan, so that a central contact point is available for the condition monitoring system.

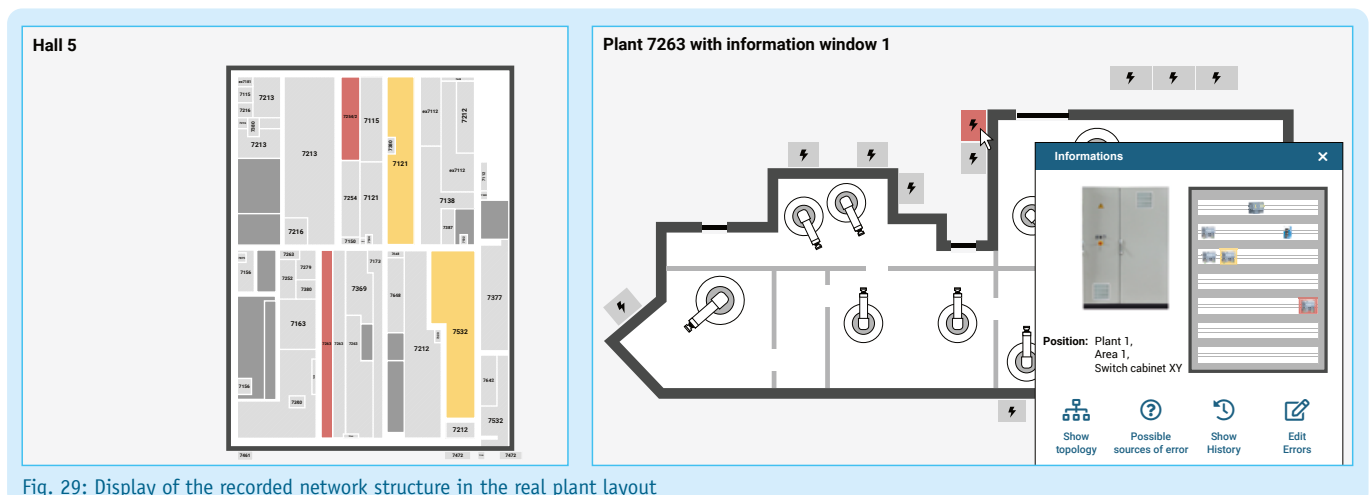

Fig. 29: Display of the recorded network structure in the real plant layout



PROmanage® NT

Network history

How is my network?

The network history provides a quick and clear overview of:

- The current network status
- How long a network has run without error
- When the last error occurred (with time stamp)

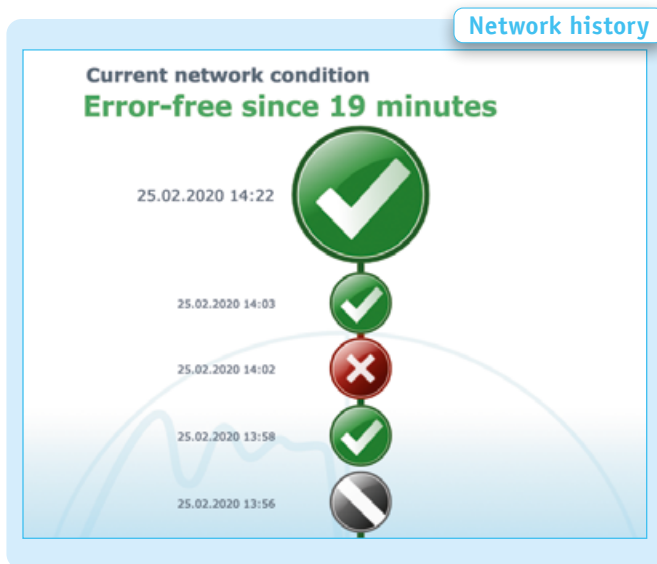

Network condition graph

A user-friendly interface can be used to display and evaluate the information. The interface can be adapted to your unique needs and spread over several physical screens for better overview.

Various parameters of different devices such as device temperature and failures can be compared in a graph to detect links in the event of malfunction.

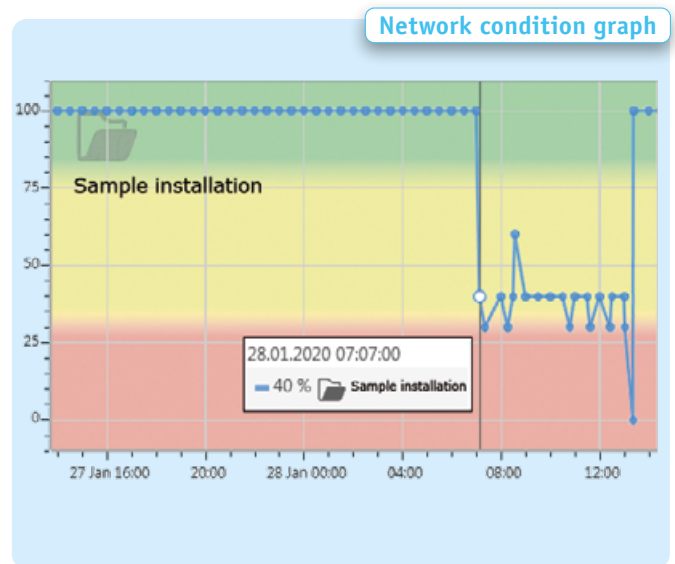

Event messages with time stamp

With the integrated threshold management threshold values can be defined for every network parameter. When a limit is reached an entry with a time stamp and event description is made automatically in the event list. Information about network errors can be retrieved from the event list with a mouse click.

Event messages with time stamp

Message type	Message	Date
Node	Threshold exceeded INBLOX 03 Segment 8 - Ch. 1 - DP Diag Parameter value 4 Bus node restart	5/5/2020 12:26:00 PM
Node	Threshold exceeded INBLOX 03 Segment 8 - Ch. 1 - DP Diag Parameter value 4 Repeat telegrams per bus cycle	5/5/2020 12:26:00 PM
Node	Threshold exceeded INBLOX 03 Segment 8 - Ch. 1 - DP Diag Parameter value 4 Internal diagnosis	5/5/2020 12:26:00
Node	Threshold exceeded INBLOX 03 Segment 8 - Ch. 1 - DP Diag Parameter value 4 External diagnosis	5/5/2020 12:26:00 PM

Alarm management

Integrated alarm management enables automatic forwarding of device notifications. By selecting suitable information medium (email, message services, OPC, SNMP) all messages can be transmitted to the responsible persons in a timely fashion. This shortens notification paths and prevents undesired plant breakdowns.

Alarm management

Available parameters

- ASi-Inspektor
- INBLOX
- PROFIBUS-Inspektor
- PROFIBUS-Inspektor NT
- PROFINET-Inspektor
- PROFINET-Inspektor NT
- PROFINET device/switch
- IP device

Available traps

- High priority alert
- Low priority alert
- Bus node failure
- Error telegrams
- Telegram gaps
- Telegram overtakes
- Load ratio
- Telegram jitter
- Broad and Multicast telegrams
- Device temperature
- Cycle time (max)
- Cycle time (min)
- Network load (max)
- Network load
- Unavailability counter
- State graph

Available parameters Available traps

Email OPC SNMP trap



Configuration example (PNM)

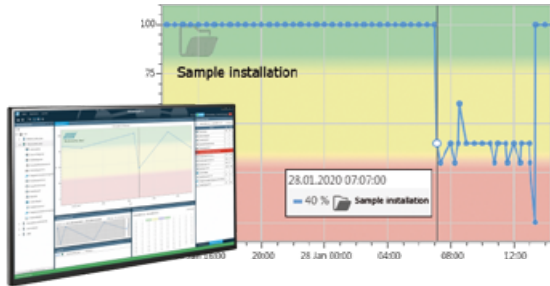

PROmanage NT - external

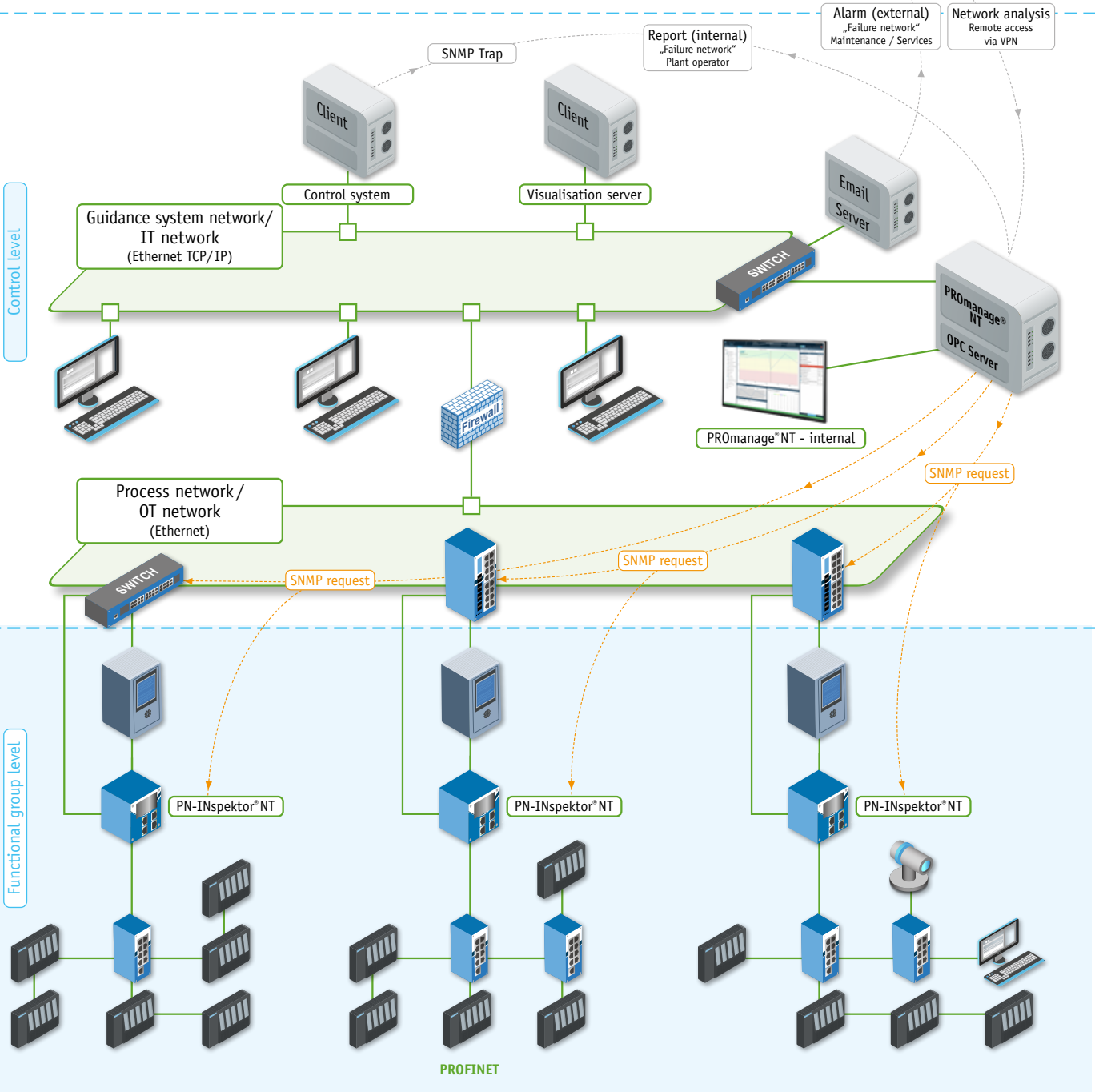
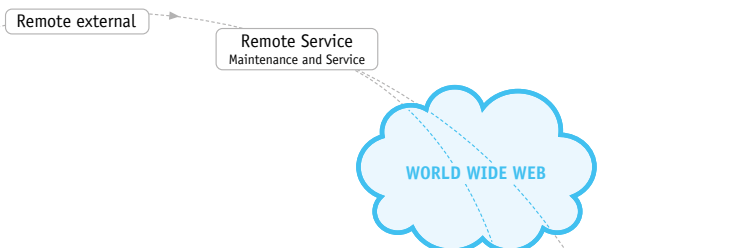

PROmesh Switch product families



PROFINET Switches

The Indu-Sol PROFINET switch family PROmesh comprises switches, which have been matured and specialized based on market needs so that with the PROmesh series any PROFINET network can be built without any problems. All PROmesh switches of the B- and P-product families meet the Conformance Class B - specifications.

The manageable PROmesh switches can be integrated into the automation system (Step7, TIA Portal) with an engineering tool in order to enable network diagnostics. With this feature among other things, these necessary and useful functions are supported:

- Sending device diagnostics to the controller (PN-RTA)
- Neighborhood detection (LLDP)
- Port-related network statistics (PDEV)
- Network diagnostics via IT mechanisms (SNMP)
- Higher availability through ring redundancy (MRP)

In addition, the PROFINET switches are certified according to Netload Class 3. This means that the switches and the resulting networks are also equipped to handle high data volumes.

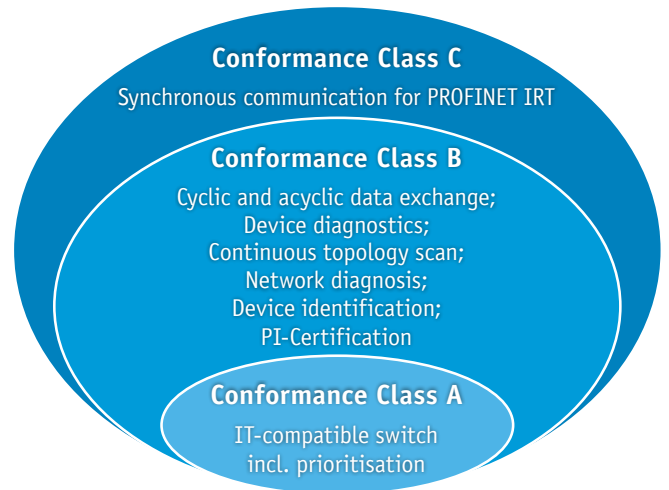

Netload Classes	Conformance Classes
<p>The classes specify at what percentage network load under different conditions, the devices must function normally.</p> <p>For example, error-free functionality is only guaranteed for Netload Class 1 devices and a multicast and broadcast load is only guaranteed up to 0.01% network load, and in contrast for Netload Class</p>	<p>The range of functions of PROFINET IO devices is clearly divided into conformance classes. These offer a practical summary of various minimum properties.</p> <p>For infrastructure components, such as switches, Conformance Class B is of particular importance, since it contains the basic PROFINET functionalities and thus meets the requirements for 99% of PROFINET networks installed in the field.</p>



Abb. 30: PROmesh Switch product families

Increased network diagnostics with the PROmesh P product family

Permanent line diagnosis

A line certification at the commissioning of the plant is not always a guarantee that the longevity of the line and thus of the plant over the entire life cycle is guaranteed. Especially when if the lines are exposed to continuous external influences which accelerate the aging process of the line, such as for example by

- Alternating bending stresses
- Robot application
- Chemicals and other liquids

In such cases, permanent line monitoring by means of a switch, such as the PROmesh switches from the company Indu-Sol GmbH, provides a remedy. These enable a dynamic analysis of the actual condition of the directly connected lines.

Unlike well-known line testers, the PROmesh switches perform the line diagnostics permanently and during ongoing system operation. Thanks to this permanent monitoring critical line conditions can be detected automatically and corrected by your maintenance department - before your system operation is impaired.

EMC monitoring

The cause of a communication interruption is not always a defective line, but also interfering shield currents on the data lines can also lead to a network failure.

To prevent this, the PROmesh switches of the series can permanently monitor the leakage current via the top-hat rail, alarm if the leakage current exceeds the limit and thus identify and, at best, eliminate them.

PROmesh line monitoring



19" Switches - The connection to IT

The PROmesh B28-RL rounds off the PROmesh product range as a 19-inch switch. The switch is intended for machine and plant superordinate communication.

With the switch, several individual plants can be connected without any communication problems.

Via certain Layer-3 functions in the PROmesh B28-RL it is also possible to logically separate the physical connections between the machines, if the security requirements dictate. For this purpose the switch has NAT routing and access control list as well as 802.1X authentication.



Abb. 31: P10X in OT-network-environment



IP67 range: The PROmesh P10X

So that not for each individual switch paired with a network diagnostics, a separate control cabinet has to be set up the PROmesh P10X combines high network performance and

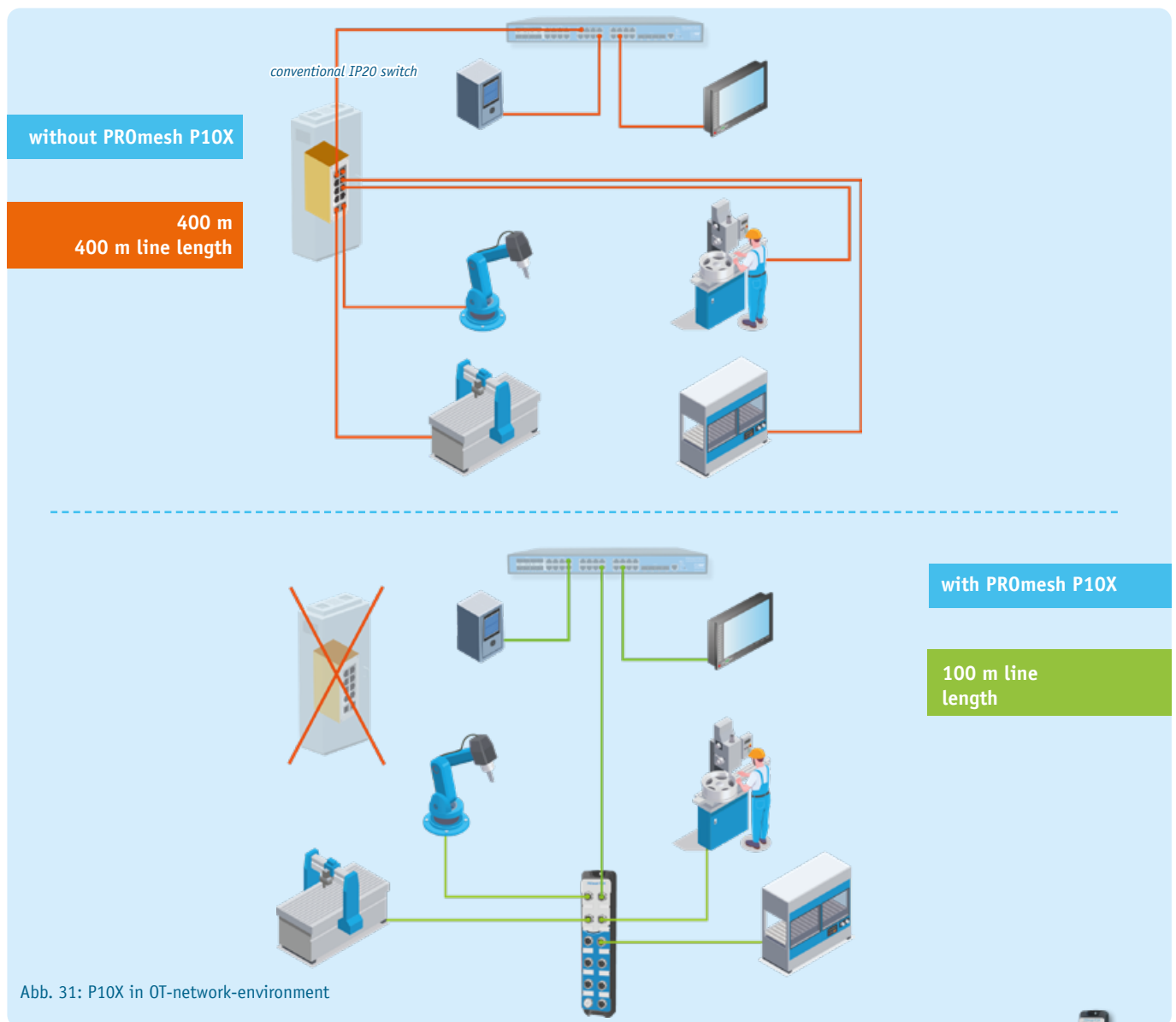
diagnostic options with the IP67 requirements. For the first time under the IP67 switches, the PROmesh P10X supports permanent line diagnostics.



PROFINET measuring points PNMA II / PNMX

The PNMA II provides feedback-free access for telegram recording in the PROFINET and other Ethernet-based networks during running production. We recommend installing the PNMA II measuring point permanently in the network connection between the automation device (controller) and the first switch, because the major part of the communication typically passes through here.

The measurement point with the PNMX version and IP 67 protection can be installed in rough production environments without any protective housing. Diagnostic tools are connected via M12 measurement jacks (M12 D-coded).

Function

For the feedback-free connection of an analysis tool (e.g. **PROFINET-INspektor[®] NT** or laptop) two monitor sockets (M1 and M2) are available on the **PNMA II / PNMX** for diagnostics. This means both communication directions can be monitored simultaneously.

An analysis tool is connected to the monitor sockets by means of two network cables. For analysis and evaluation of the measurement results the telegrams from both communication directions can be overlaid. The **PNMA II / PNMX** does not discard error telegrams. Instead, it forwards them.

Highlights

- If connecting a **PROFINET-INspektor[®] NT** via a **PNMA II**, only two additional patch cables are needed (no crossover cable required).
- In case of a power supply failure the PROFINET communication via the **PNMA II** remains intact.
- Power supply of additional analytic tools via the UOUT (24VDC) connector
- **PNMX IP 67** for rough production environments

Properties

- Monitoring of all protocols
- Supports all packet sizes
- No packet loss
- All connection ports on the front panel
- No additional effort to connect a measuring device
- Tested interaction with the **PROFINET-INspektor[®] NT**
- No free switch port necessary
- Bi-directional data transmission up to 100 Mbps
- No network interruption when connecting diagnostic tools

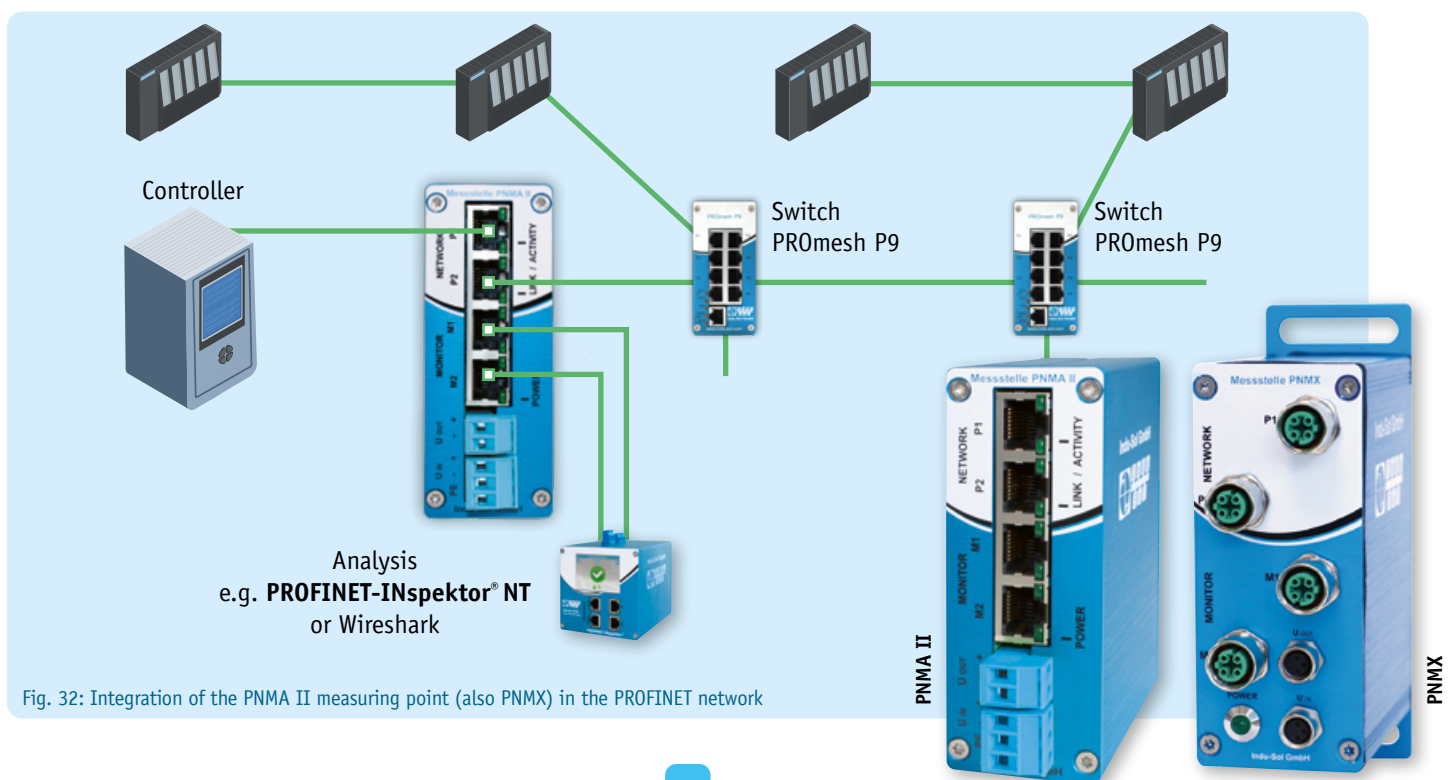

Fig. 32: Integration of the PNMA II measuring point (also PNMX) in the PROFINET network

SIEDS

With its self-learning teach mode and intelligent alarm management, the SIEDS sensor can be used for any type of condition monitoring in predictive maintenance and offers the possibility to evaluate a wide variety of assets in the industrial environment.



usecase:
Condition monitoring on motor pump combination

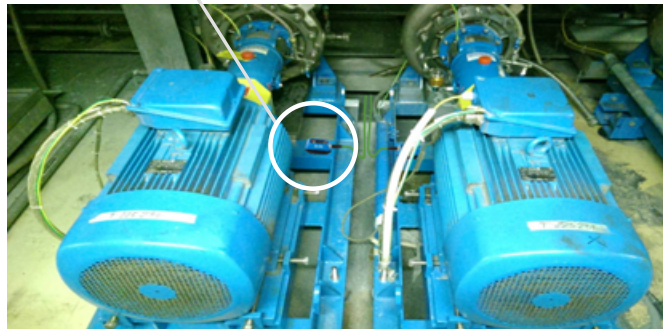

Technical Data	
• Network connection:	M12 D-coded
• Transmission rates:	100 Mbps
• Power supply:	Power over Ethernet
• Operating temperature:	-40°C to +70°C
• Protection class:	IP65
• Mounting:	Direct mounting
• Protocol interfaces:	RestAPI, MQTT, HTTPS

Sensors



D*Bridge

The D*Bridge is an intelligent bridge device, which connects two or more fieldbuses on the OT level to one network. The device is used without configuration and is therefore ideal for users without a high level of IT knowledge.

Without any configuration effort both from the PLC's point of view as well as via its own interface, the D*Bridge routes the relevant data traffic and thus enables horizontal communication.

The D*Bridge increases the performance and security of the network by forwarding only the relevant data packets and discarding unwanted or faulty packets.

Any additional data traffic is blocked, thus stabilizes the network and ensures availability. The D*Bridge has a much higher range of functions than the usual fieldbus couplers.

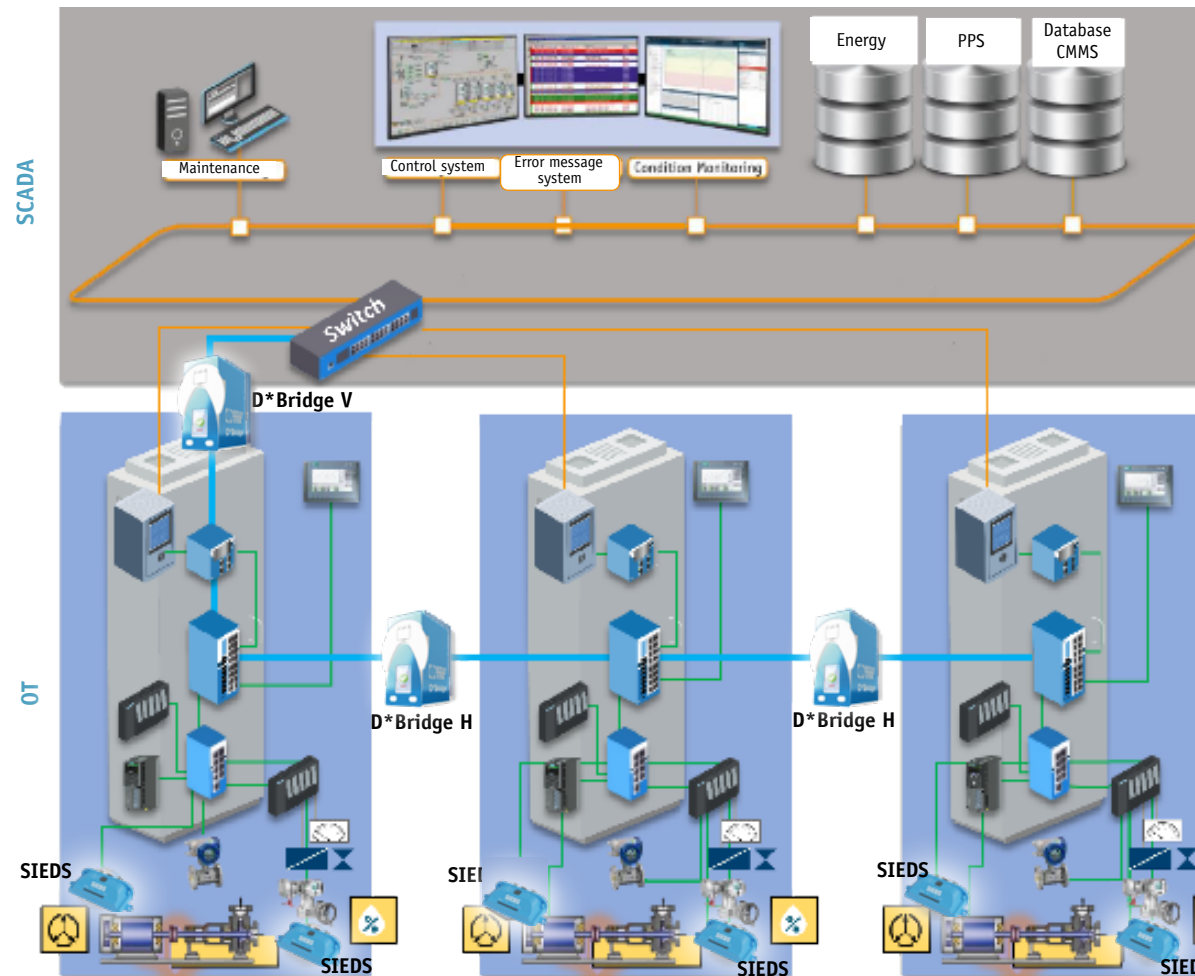

With the D*Bridge, homogeneous fieldbuses are safely combined into networks. Simple, pragmatic, effective. This is how you create the basis for significant automation gains at the maintenance level.



D*Bridge H

Creates secure, homogeneous convergent network structures for digitalization between fieldbuses on the shopfloor level.

D*Bridge V

Creates the secure connection of the homogeneous convergent network structures for processing of the smart sensor data from the shopfloor directly to the SCADA level.



Infrastructure components



Premium PROFINET Switches

Ordering Details	Art.-No.
PROmesh P8+F	114110198
PROmesh P9+	114110194
PROmesh P10+	114110204
PROmesh P10X	114110211
PROmesh P20	114110022



Basic PROFINET Switches

Ordering Details	Art.-No.
PROmesh B8	114110501
PROmesh B16	114110510
PROmesh B8 compact	114110520

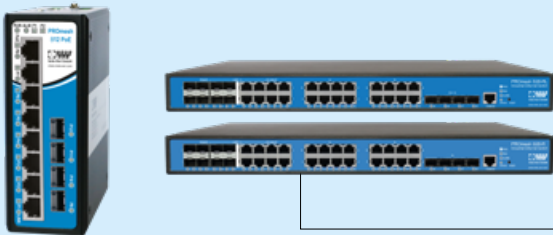

Ethernet Switches

Ordering Details	Art.-No.
PROmesh B12 PoE	114110251
PROmesh B28-R	114110100
PROmesh B28-RL	114110110



Unmanaged Ethernet Switches

Ordering Details	Art.-No.
PROmesh U3	114110130
PROmesh U5	114110120
PROmesh U8	114110122
PROmesh U16	114110124

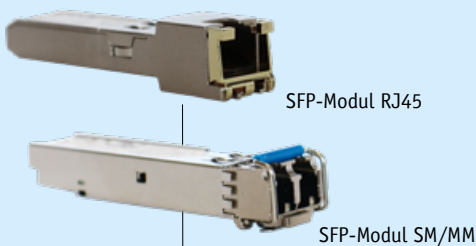

SFP-Module

Ordering Details	Art.-No.
SFP-Modul 1 Gbit/s RJ45 100 m	114120003
SFP-Modul 1 GBit/s 20 km SM-LC	114120004
SFP-Modul 1 GBit/s 0,55 km MM-LC	114120005
SFP-Modul 100 MBit/s 2 km MM-LC	114120006
SFP-Modul 100 MBit/s 10 km SM-LC	114120007
SFP-Modul 10 GBit/s 10 km SM-LC	114120008
SFP-Modul 10 GBit/s 0,3 km MM-LC	114120009
SFP-Modul 2,5 GBit/s 0,55 km MM-LC	114120020
SFP-Modul 2,5 GBit/s 10 km SM-LC	114120021

Infrastructure components



PROFINET BLUambas®

PROFINET wireless system via Bluetooth

Ordering Details	Art. No.
BLUambas® PN classic IP20* (4 device participant)	125100200
BLUambas® PN classic IP65* (4 device participant)	125100201
BLUambas® PN comfort IP20* (6 device participant)	125100202
BLUambas® PN comfort IP65* (6 device participant)	125100203
BLUambas® PN premium IP20* (6 dp + PROFIsafe)	125100204
BLUambas® PN premium IP65* (6 dp + PROFIsafe)	125100205

*Antennas and accessories on request

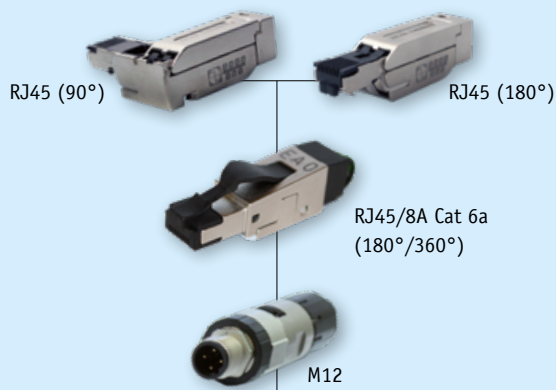

PROFINET plugs

RJ45 / M12 Fast Connect

Ordering Details	Art. No.
PROFINET plug RJ45 (180°)	114030003
PROFINET plug RJ45 (90°)	114030004
PROFINET plug RJ45/8A Cat 6a (180°)	112030008
PROFINET plug RJ45/8A Cat 6a (360°)	112030009
PROFINET plug M12	114030002

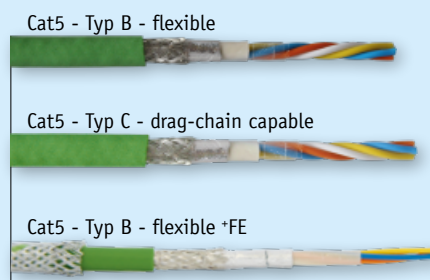

PROFINET cable

Cat5 / +FE (flexible / drag-chain capable)

Ordering Details	Art. No.
PROFINET cable Cat5 (Typ B - flexible)	114060001
PROFINET cable Cat5 (Typ C - drag-chain capable)	114070001
PROFINET cable +FE (Typ B - flexible)	114060003

PROFINET tools

Ethernet Fast Connect Stripping Tool



EmFlex Stripping Tool



Stripping Tools

Ordering Details	Art. No.
Ethernet Fast Connect Stripping Tool	112020005
EmFlex Stripping Tool	122130010

SIEDS



SIEDS

Ordering Details	Art.-No.
SIEDS	124110000

D*Bridge



D*Bridge V



D*Bridge H

D*Bridge

Ordering Details	Art.-No.
D*Bridge V	112100101
D*Bridge H	112100100

Network planning

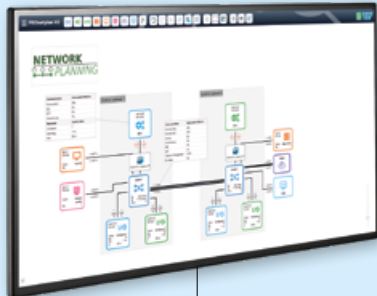

PRONetplan (see page 10)

Network planning software

Ordering Details	Art. No.
PRONetplan	114010009

Analysis | Diagnostics | Measurement



ETHERtest V5 (see page 12)

PROFINET Cable tester (suitable for certification)

Ordering Details	Art. No.
ETHERtest V5.1 (extendable for FOC)	112010011
ETHERtest V5.3*	112010022



PROlinetest (see page 12)

PROFINET Cable tester

Ordering Details	Art. No.
PROlinetest*	112010010



PROscan® Active V2 (see page 13)

Active acceptance test and validation software

Ordering Details	Art. No.
PROscan® Active V2 – 1x license* (Basic license)	117000053
PROscan® Active V2 – 5x license*	117000057
PROscan® Active V2 – 25x license*	117000061
Upgrade PROscan® Active V1 to V2	117000052

*All adapters for PROlinetest and ETHERtest V5.1/V5.3 on request.

*Further licences upon request

Analysis | Diagnostics | Measurement



PROFINET-INspektor® NT (see page 17)

Analysis and diagnostic tool

Ordering Details	Art. No.
PROFINET-INspektor® NT	124030100



iPNMA (see page 23)

PROFINET intelligent measuring point

Ordering Details	Art. No.
iPNMA	114090200



PROFINET DiagnosticDUO (see page 21)

PROscan® Active V2 (1x license)

PROFINET-INspektor® NT

Ordering Details	Art. No.
PROFINET DiagnosticDUO	124030020



PROFINET Diagnostic set (see page 22)

All essential tools for commissioning and troubleshooting

- Analysis and diagnostic tool **PROFINET-INspektor® NT**
- Topology software **PROscan® Active V2**
- Network monitoring software **PROmanage® NT**
- Cable tester **PROlinetest** (optionally incl. **ETHERtest V5.1/V5.3**)
- Leakage current measuring clamp **EmCheck® LSMZ I**

Ordering Details	Art. No.
PROFINET Diagnostic set (with PROlinetest)	114010020
PROFINET Diagnostic set (with ETHERtest V5.1)	114010040
PROFINET Diagnostic set (with ETHERtest V5.3)	114010054

Permanent network monitoring



PROmanage® NT (see page 24)

Network monitoring software

*The licence defines the maximum number of network ports or devices retrieved simultaneously. (Ethernet switch: number of network ports = number of licence ports, 1 PB-INSpektor® = 8 ports, 1 PN-INSpektor® = 16 ports)

Ordering Details	Art. No.
Upgrade NT to NT V2	117000100
PROmanage® NT (80 Ports*)	117000104
PROmanage® NT (320 Ports*)	117000106
PROmanage® NT (640 Ports*)	117000110

*Further licences upon request

EMC analysis | EMC diagnosis | EMC measurement



EmCheck® LSMZ I (see page 22)

Leakage current measuring clamp

Ordering Details	Art. No.
EmCheck® LSMZ I	122010005
Set of measuring clamps (LSMZ I and MWMZ II)	122010006



EmCheck® MWMZ II

Mesh resistance measuring clamp

Ordering Details	Art. No.
EmCheck® MWMZ II	122010010
Set of measuring clamps (LSMZ I and MWMZ II)	122010006

Infrastructure components



PNMA II



PNMX IP67

PNMA II / PNMX (see page 31)

PROFINET measuring points

Ordering Details	Art. No.
PNMA II	114090100
PNMX IP 67 (for rough production environments)	114090300

Maintenance and management strategy at the shopfloor level

Our team of 40 network specialists offers industrial companies throughout Europe the daily support needed to appropriately and purposefully meet every type of challenge that can arise from the operation of machine networks.

No matter which maintenance strategy you pursue in your company:

We advise, plan, prepare projects and manage for you the decisive measures that increase overall system effectiveness

ess significantly, stabilise production processes and open up access to previously unattainable potential savings.

In future, the digitalisation know-how in our condition monitoring systems will not only extend to the network itself, but also extend to the network itself, but

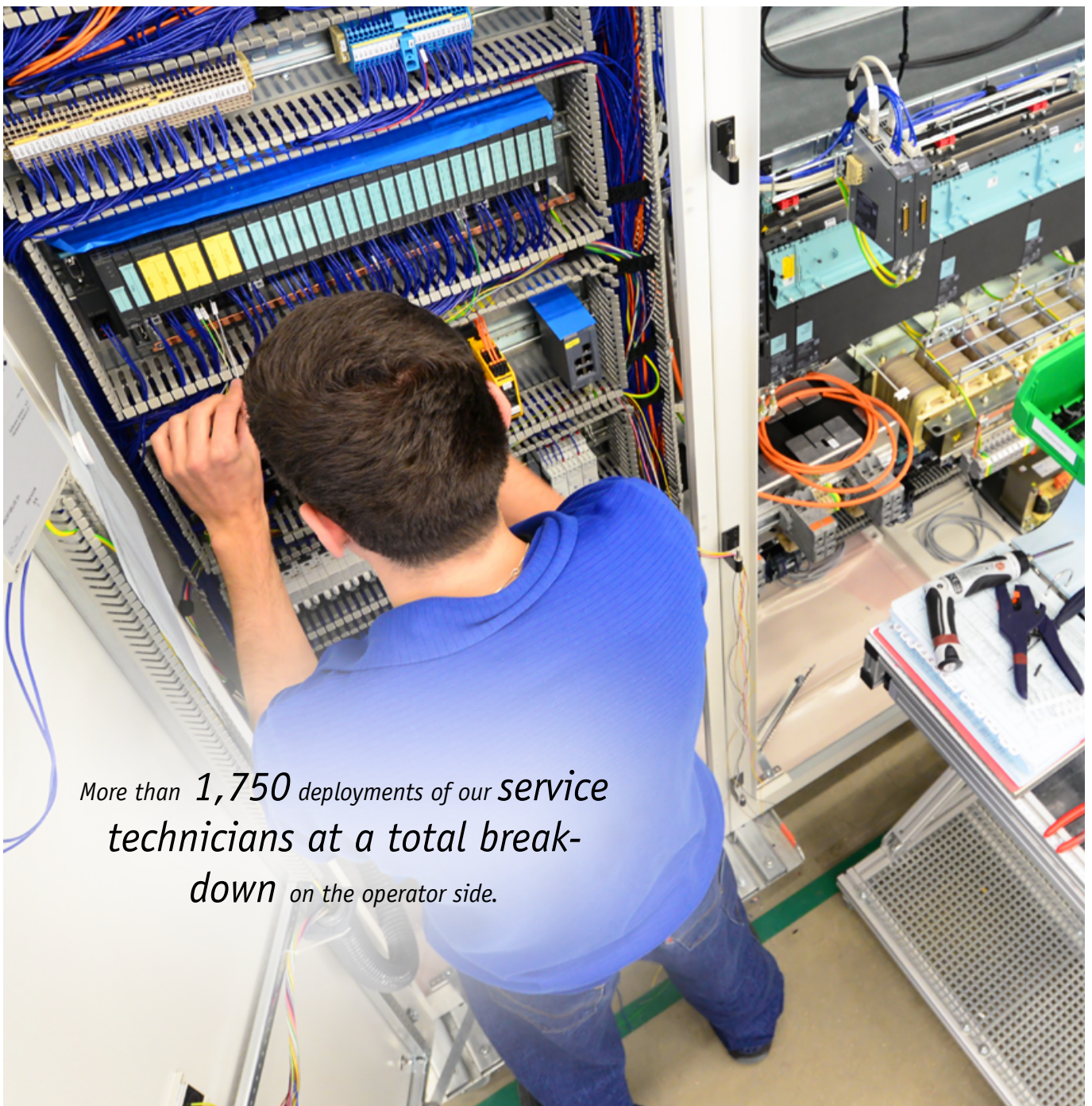

More than 1,750 deployments of our service technicians at a total breakdown on the operator side.



Condition Monitoring Systeme

automate the maintenance activities

We extend the CMMS* to include multi-sensors (SIEDS*) and an OT security device (D*bridge) and create the basis so that installers and operators receive equal access to the data streams below the PLC.

The result will be that in future, many routine tasks (such as inspections and similar) can be automated and worked through in a structured way. A valuable contribution with which we will help industry to deal with the shortage of skilled maintenance workers.

Make your maintenance strategy more successful and make your machine networks real value drivers in the company, which will pay directly into the operating result.



Planning productive OT networks

Network planning is one of the unique competencies of InduSol, which enable customers to increase strategic network improvements at any time and achieve significant improvements when it comes to availability and performance.

We consider the whole network and generally achieve the required goal with up to 40% lower production costs.



Training offers for all aspects of industrial networks

As a long-standing specialist for industrial networks and an official PI training centre, we are extremely familiar with the optimisation of automation networks.

Based on our experiences and extensive expertise, we offer you practice oriented further training courses for PROFINET, PROFIBUS & Co.

Benefit from our know-how and become an expert!



Consulting for OT and IIT networks and integrations

Our experts are already undertaking the field level network management for several of our most renowned customers. Working closely with the maintenance on site – via remote – together we are already developing the forward-looking network management of tomorrow today.

Installers and operators benefit equally from our advisory expertise, which we contribute during the strategy and planning phase.



Our planning expertise sets itself apart through:

- » clear structures in the network without weak points and unnecessary redundancies
- » optimisation of the maximum network load, the overall performance and making sure that the hardest real-time requirements are met
- » security and continuity through segmentation
- » We plan greenfield and brownfield projects to be <|digital ready|> so that the OT can deliver the data for optimising the production processes in the IT.
- » independent device selection

*CMMS = Condition Monitoring Management Systems

*SIEDS = smart industrial environment digitalization sensor

The benefits for your business

In order for these comprehensive and integrative processes and services to succeed, advice and network planning that bring together the interests of the installers involved as well as those of the operator are needed in the strategy phase. The result is more benefits, availability and performance for significantly lower costs (generally approx. 40%), with a clearly defined network for the installation phase.

This saves valuable time and costs for the commissioning of the system. We offer this integrative advisory and planning service for all brownfield and greenfield projects.



SOS Network Service – always there when it's really urgent

In **2022**, our network experts were called out to approx. **150 SOS deployments** on site (in industry).

The reasons for these are generally massive faults in the production process or total breakdowns, which are caused by a reactive maintenance strategy, which exceed the client's resources and know-how.

We have used the events of recent years as an opportunity – to review how the quality of machine networks and the opportunities for operating proactive condition monitoring have developed.

» **2.3 billion of lost profits due to reactive maintenance. 90% could have been avoided.**

Five numbers really surprised us:

1. More than **1,750 deployments** of our technicians at a total breakdown on the operator side.
2. **2.3 working days** average until stable running of the plant/system is restored.
3. Indirect maintenance costs of **Ø 30,000/hour**, due to (material loss, lost profits, cleaning and disposal costs, etc.)
4. The industrial customers who called out our technicians to SOS deployments during this period incurred more than **2.9 billion** in lost profits due to total breakdowns.
5. Many companies use these severe experiences as an opportunity and set up a forward-looking maintenance regime. But what is truly astonishing is that approx. **62%** of the companies continue to opt for reactive maintenance and call us out to SOS deployments again.

And another surprising number:

The reasons for more than **90%** of these downtime costs could have been identified in good time and prevented with proactive **condition monitoring** and **predictive maintenance**.

Digitalisation and OT/IT integration are changing everything

Due to the increasing digitalisation of the field level, sweeping changes result within the classic job descriptions. New task profiles result.

Apart from production planning and control, this also severely affects maintenance. Due to the integration of OT and IT in particular, new specialists are sought who know their way around the needs of both spheres. Nevertheless, the classic maintenance must continue to ensure the availability of the plants and systems in a structured way and with maximum security.

The classic OT organisation not only meets its limits with regard to content but above all in terms of personnel. The new objective is to automate the core process and constantly recurring maintenance tasks economically and efficiently.

The three network services described in the following, in combination with our system know-how at the system condition monitoring management level and forward-looking maintenance offer a massive economic contribution. And do so depending on the integration depth in the customer's processes.



PowerUp Service – we determine how the network in your plant is doing

Our service technicians carry out extensive examinations of the plant condition on the network level, record the plant condition as part of an inspection and assess the network

quality. You then decide what happens next. We are there at your side whenever it's necessary.



Network CareUp Service – we support you with your network management when support is necessary

This service is a supplementary configuration stage to the PowerUp service. Then, based on the analysis of the results, our network experts work with the client to develop an offer

with supporting maintenance offers, e.g. in the form of regular updates, etc.



Network SmartUp Service – provision of network monitoring of the defined plants/systems

- » We develop the optimisation measures and draw up the timetables for the implementation.
On request, we provide advice and support for the measures through to the final implementation.
- » Creation of a catalogue of measures for the defined networks in the event of technical problems
- » Testing & adjustment of the threshold values for the alarm management for Indu-Sol hardware and software of the defined networks
- » Database maintenance by Indu-Sol
- » Software of the defined networks



Network EmpowerUp Service – Provision of network monitoring + protection measures for network-related plants

- » *The content of all services is based on the SmartUp service*
- + Database maintenance by Indu-Sol software of the defined networks
- + Implementation of the planned measures to secure plant availability



Network ManageUp Service – Provision of network support + network management of network-related plants

- » *The content of all services is based on the SmartUp service*
- + Implementation of the planned measures to secure plant availability
- + Spare parts stocking
- + 24/7 availability and on-call

InduSol America

980 Birmingham Rd. Ste 721
Alpharetta, GA 30004 USA

Telephone: +1 (678) 880-6910

info@indusolamerica.com
www.indusolamerica.com

Certified according to DIN EN ISO 9001:2015

Indu-Sol GmbH

Blumenstrasse 3
04626 Schmoelln



PROFINET - The Movie | Technology Made Easy

www.indusolamerica.com/profinet

or use the QR code directly