

User's Manual

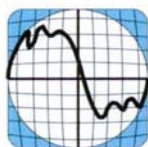

ProfTest II

PROFIBUS Test Tool



I n d u
Industrial Solutions
S o l

Table of Contents

1 Scope of Delivery.....	1
2 Safety Advice.....	2
3 Introduction	3
4 Line Tests.....	5
4.1 Line Measurement.....	5
4.2 LiveList, SlaveDiag, and Level Detection	6
4.3 Measurement at the Running Bus	6
5 NetTEST II Menu Guide	7
5.1 Start-Up / Setting in Operation	7
5.2 Main Menu.....	8
5.2.1 Test without PLC	9
5.2.1.1 Segment list.....	10
5.2.1.2 Test with no terminators	12
5.2.1.3 Test with 1 terminator.....	16
5.2.1.4 Test with 2 terminators	18
5.2.1.5 Generate livelist.....	19
5.2.1.6 Slave ident number	20
5.2.1.7 Slave signal quality.....	21
5.2.1.8 Baud rate detection	22
5.2.2 Test protocol	23
5.2.2.1 Create new protocol	23
5.2.2.2 Delete	25
5.2.2.3 Display	25
5.2.2.4 Transmit	25
5.2.2.5 Test company.....	26
5.2.2.6 User name list.....	26
5.2.2.7 Customer list.....	27
5.2.2.8 Plant list	27
5.2.2.9 Segment list.....	28
5.2.3 System configuration.....	28
5.2.3.1 RS232 Interface	28
5.2.3.2 Device properties	29
5.2.3.3 Date / Time.....	30

Contents

5.2.3.4 Basic parameters.....	30
5.2.3.5 Load parameters	32
5.2.3.6 Send parameters.....	32
5.2.3.7 Firmware update.....	33
5.2.4 GSD - library	33
5.2.4.1 New File	33
5.2.4.2 Receive GSD File.....	34
5.2.4.3 Delete GSD File.....	34
5.2.4.4 Display / Edit.....	34
6 Communication with a PC.....	35
6.1 Characteristics of HyperTerminal	35
6.2 COM Interface Configuration.....	36
6.3 Receive Test Protocol	37
6.4 Send File to NetTEST II.....	38
6.5 Send file from NetTEST II to the PC	39
7 Systems with PROFIBUS -Master Option.....	40
7.1 Slave line-up	41
7.1.1 Set outputs	43
7.1.2 Read inputs	43
7.1.3 Set value	43
7.1.4 Read value	43
7.1.5 Read diagnostics	43
7.2 Extended master	44
7.2.1 Master parameters.....	44
7.2.1.1 PROFIBUS Address.....	45
7.2.1.2 Profibus parameters	45
7.2.1.3 Copy from segment.....	46
7.2.2 Config. with livelist.....	46
7.2.3 COMSOFT Configurator Tool.....	47
7.2.3.1 Creation of a configuration	47
7.2.4 Config. with download	49
7.2.5 Slave menu	51
7.2.5.1 New slave	51
7.2.5.2 Copy slave	54
7.2.5.3 Delete slave.....	54
7.2.5.4 Process slave.....	54

7.3 Process slave	55
7.3.1 Edit parameters	55
7.3.1.1 Profibus address	56
7.3.1.2 General parameters	56
7.3.1.3 Prm data	56
7.3.1.4 Cfg data	56
7.3.1.5 DP tag definitions	56
7.3.2 Line-up	56
7.3.2.1 Line-up	58
7.3.2.2 Edit slave address	58
7.3.2.3 Edit slave parameters	58
7.3.2.4 Edit prm. data	58
7.3.2.5 Edit cfg. data	59
7.3.2.6 Edit xchg. data	59
7.3.2.7 Show xchg. data	59
7.3.2.8 Edit DPTag output	59
7.3.2.9 Show DPTag input	59
7.3.2.10 Show Slave diagnostic	60
7.3.3 Single DP services	60
7.4 DPTag definitions	61
7.4.1 Display/edit tag	62
7.4.2 Create new tag	63
7.4.3 Delete tag	63
8 System with Online Functionality	64
8.1 Baud rate detection	66
8.2 Generate livelist	67
8.3 Rotation time	68
8.4 Signal level measurement	69
8.4.1 Measurement with livelist	70
8.4.2 Measurement with filter	70
8.4.2.1 Define filter	71
8.5 Signal level summary list	72
8.6 Event log	73
8.7 Event count	74
8.8 Diagnostic event	75
8.9 Settings	76

Contents

9 Operation of the Battery Charger.....	77
10 Tips & Tricks.....	78
10.1 Cable Lengths in PROFIBUS Segments.....	78
10.2 Segment Cascading	78
10.3 Use of Stub Lines.....	79
11 Pin Assignment.....	80
12 Key Allocation.....	81
13 Problematic Slaves	82
14 Frequently Asked Questions: FAQ.....	83
15 Technical Data	85
15.1 NetTEST II.....	85
15.2 Plug Charger	86

Tables

Table 1	Segment length specification	78
Table 2	Pin assignment of D-SUB 9 connector	80
Table 3	Key allocation NetTEST II	81
Table 4	Technical data NetTEST II	86
Table 5	Technical data Plug charger	86

Figures

Figure 1: Connection **NetTEST II** in the cable thread..... 5

Figure 2: Screen ‘Start-up’ 7

Figure 3: Screen ‘Main menu’ 8

Figure 4: Screen ‘Test without PLC’ 9

Figure 5: Screen ‘Segment list’ 10

Figure 6: Screen ‘Segment configuration’ 10

Figure 7: Screen ‘Test with no term’ 13

Figure 8: Screen after ‘Test with no term’ 13

Figure 9: Screen after ‘Test with 1 term.’ 16

Figure 10: Screen after ‘Test with 2 term.’ 18

Figure 11: Screen ‘Generate livelist’ 19

Figure 12: Screen ‘Slave ident number’ 20

Figure 13: Screen ‘Slave signal quality’ 21

Figure 14: Screen ‘Baud rate detection’ 22

Figure 15: Screen ‘Test protocol’ 23

Figure 16: Selection menu ‘Test protocol’ 23

Figure 17: Screen ‘Test protocol with PLC’ 24

Figure 18: Screen ‘Test Company’ 26

Figure 19: Screen ‘User name list’ 26

Figure 20: Screen ‘Customer list’ 27

Figure 21: Screen ‘Plant List’ 27

Figure 22: Screen ‘System configuration’ 28

Figure 23: Screen ‘Device properties’ 29

Figure 24: Screen ‘License code’ 29

Figure 25: Screen ‘Basic parameters’ 30

Figure 26: Screen ‘GSD - library’ 33

Figure 27: Connection Setting via COM1 35

Figure 28: Characteristics of the serial interface 36

Figure 29: "Start-up" Screen with the PB-Master 40

Figure 30: Screen ‘Line test’ 40

Figure 31: Screen ‘Profibus master mode’ 41

Figure 32: Screen ‘Slave line-up’ 41

Figure 33: Screen ‘Slave line-up’ 42

Figure 34: Screen ‘Extended master’ 44

Figure 35: Screen ‘Master parameters’ 44

Figure 36: Screen ‘Other address’ 45

Figure 37: Entry mask ‘Master configuration’ 45

Figure 38: Screen ‘Config. with livelist’ 46

Figure 39: Screen ‘context menu in the *Configurator*’ 47

Figure 40: Slave –Configuration Dialogue..... 48

Figure 41: Screen ‘Receive CFG file’ 49

Figure 42: Download *Configurator* -Tool dialogue 50

Contents

Figure 43:	Confirmation Screen 'Receive CFG file'	50
Figure 44:	Screen 'Slave menu'.....	51
Figure 45:	Selection menu 'New address'.....	51
Figure 46:	Entry mask 'Parameter'.....	52
Figure 47:	Entry mask 'User prm'.....	53
Figure 48:	Entry mask 'Cfg data'.....	53
Figure 49:	Selection menu 'Copy slave'	54
Figure 50:	Screen 'Process slave'.....	55
Figure 51:	Screen 'Edit parameter'.....	55
Figure 52:	Screen 'Line up'.....	58
Figure 53:	Screen 'Single DP services'.....	60
Figure 54:	Screen 'Tag(s) use/modify'.....	61
Figure 55:	Selection menu 'Display/edit tag'.....	62
Figure 56:	Entry mask 'Tag data'.....	62
Figure 57:	"Start-up" Screen with Online Function	64
Figure 58:	Screen Line test.....	64
Figure 59:	Screen Test with PLC.....	65
Figure 60:	Baud rate detection.....	66
Figure 61:	Generate Slave livelist.....	67
Figure 62:	Generate Master livelist.....	67
Figure 63:	Rotation time	68
Figure 64:	Signal level measurement.....	69
Figure 65:	Selection menu Signal level measurement	70
Figure 66:	Measurement with filter	70
Figure 67:	Screen 'Filter name'.....	71
Figure 68:	Screen 'DP-Slave list'	71
Figure 69:	Screen 'DP-Slave sorting'	72
Figure 70:	Screen 'Signal level summary list'	72
Figure 71:	Screen 'Event log'.....	73
Figure 72:	Screen 'Event count'	74
Figure 73:	Screen 'Diagnostic event'.....	75
Figure 74:	Screen 'Settings'.....	76

1 Scope of Delivery

Included in the scope of delivery of the **NetTEST II** service case are the following items:

- one PROFIBUS **NetTEST II** cable tester
- two battery packs NiMH 4,8 V/1500 mAh
- one battery charging holder
- one 230 VAC plug-in battery charger
- power supply adapter
- one PROFIBUS Stub line 0.15 m, DB9M / DB9M
- one RS232 Cable connector DB9M / DB9F
- one PROFIBUS Y-Cable, 0.15 m, DB9M / 2xDB9F
- one PROFIBUS Bus disconnecter, DB9M / DB9F
- one Gender Changer DB9M / DB9F (mounted on **NetTEST II**)
- one Gender Changer DB9M / DB9M
- one Gender Changer DB9F / DB9F
- one Transport case
- one User's guide
- one **COMSOFT Configurator-Tool**
(for DP Master Option)

2 Safety Advice

The **NetTEST II** may only be operated with licensed NiCd batteries or NiMH batteries.

- Do not immerse battery pack under water or expose it to open fire.
- Do not open battery pack and do not try to replace individual battery cells.
- Do not dispose of faulty battery packs with normal household garbage!
- The battery pack could warm up during charging. This is a normal process and not dangerous.
- Do not use other chargers than supplied and specified by **COMSOFT**, the batteries could otherwise be damaged.
- Do not use **NetTEST II** in surroundings with explosion hazard.

☞ In case that water or other liquids should have penetrated your **NetTEST II**, remove the battery pack or the power supply adapter. Then have your **NetTEST II** checked by our Service Department. The same applies for the battery charging holder and the plug-in battery charger.

3 Introduction

With the PROFIBUS **NetTEST II** you have acquired a high-quality tool for the examination of RS485-based PROFIBUS segments.

COMSOFT's aim is to provide its users with a valuable tool for an easy check, without extensive test methods of the correct cabling of their PROFIBUS net and to document this. Furthermore, the search for errors in already installed PROFIBUS systems shall be as easy as possible. We guess that we reached this target with **NetTEST II**, the 2nd generation of **COMSOFT** PROFIBUS test tools.

Therefore it goes without saying that with **NetTEST II**, the checks can be run with connected and disconnected devices. It does not matter if the devices are powered or not. For physical testing you only have to ensure that there is no active Master (PLC) polling the bus.

Besides the standard cable test, i.e. the verification of the lines regarding **cable length**, **line impedance**, **correct termination**, **cable rupture**, **broken shield**, **stub lines**, **inhomogeneous cable segments**, **mixed up cables**, **short circuits**, **faulty PROFIBUS connectors and faulty device connections**, **NetTEST II** disposes of PROFIBUS DP specific test functions. So, e.g. the **livelist** and the **Slave Ident Number** are indicated, also the **transmission level** of the Slaves connected to the bus is detected per device. Furthermore, **NetTEST II** detects the current **baud rate** at the running bus. During the baud rate scan a **signal analysis** indicates faults or errors in the cabling.

Apart from these basic functions the following options are available for **NetTEST II**:

- **DP Master Option**
With the DP Master Option the set into operation of DP Slaves is possible without the PLC. The DP Slaves can be configured with the **COMSOFT** PROFIBUS configuration tool based on the DP Slaves appropriate GSD file.
- **Online-Function**
This function performs a detailed analysis of the telegram traffic and the physical state of the PROFIBUS line.

To make installation checks and error retrieval as easy as possible, we divided this manual into the following sections:

- Line tests
- Menu guide
- PC connection
- DP Master functionality (optional)
- Online functionality (optional)
- Tips & Tricks

We hope that we can give you with our test tool **NetTEST II** and this manual all necessary means for a faultless function of your PROFIBUS plant. In case of queries, please contact our hotline, we will be pleased to help you with our advice.

4 Line Tests

4.1 Line Measurement

Generally, measurements regarding line physics can only be made from one end of the PROFIBUS line. If you try to measure from any other place within the segment, you will obtain faulty results.

Furthermore please make sure that during measurements no Master is polling the bus or is sending tokens. Pure PROFIBUS DP Slave devices as well as e.g. repeaters and optical couplers must not be disconnected from the bus. An oversight over the possible measuring points in line segments for line measurement is depicted below:

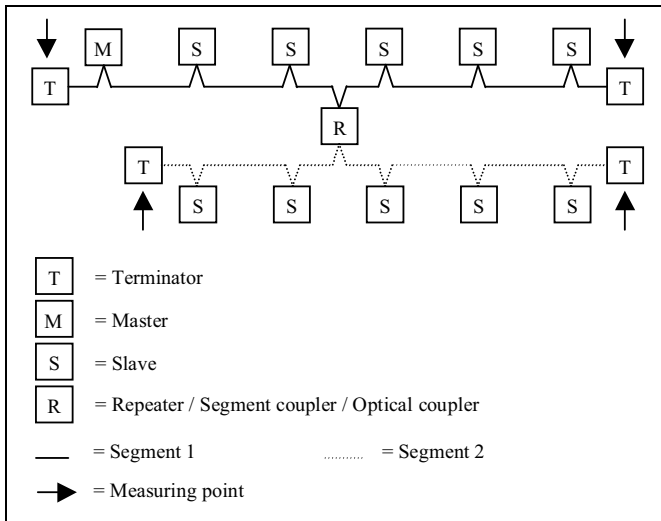

Figure 1: Connection **NetTEST II** in the cable thread

4.2 Livelist, SlaveDiag, and Level Detection

To make detections as easy as possible, the generating of the livelist, the Slave diagnosis and Slave-related transmission level detection should be effected as well from the bus end. However, you can also make these from any other available measuring point within one segment. Here, please observe that the function of the livelist and of the SlaveDiag also work via a repeater, segment coupler or optical coupler. The level detection of a Slave connected via such a device reflects only the transmission level of the repeater and not the one of the detected Slaves!



4.3 Measurement at the running bus

The measurements at the running bus are limited to an indication of the current baud rate, as well as of the general transmission level quality of the connected Slaves. By this means, a qualitative evaluation of the level on the bus line is made. If the test tool shows reflections, the reasons for those can only be found with the line detection, which implies that the Master(s) is / are being turned off.

5 NetTEST II Menu Guide

5.1 Start-Up / Setting in Operation

Check the completeness of the scope of delivery and charge batteries before first setting in operation. Remove the battery by gently pressing the locking and at the same time pulling down the battery placed at the rear lower side of the **NetTEST II**. Now place the battery into the charging holder, and check the loading procedure by means of the LED in the battery charger. For detailed information refer to the enclosed documentation of the battery charger. Remove the battery from the charging holder and push it onto the **NetTEST II** until you can hear it snapped in.

Now push the  key approx. 1s, until the PROFIBUS logo appears on the screen. Then release the  key. Besides the PROFIBUS logo, the firmware version and date appears for approx. 2s.

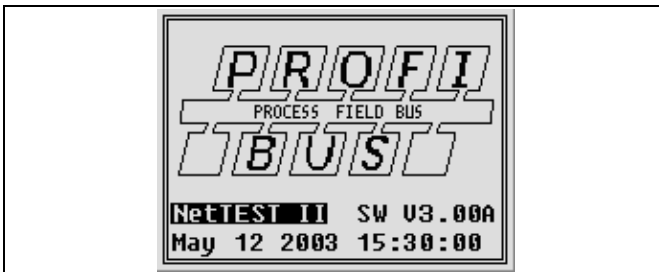



Figure 2: Screen 'Start-up'

Now the main menu is displayed automatically. The test tool is ready for operation. With various different text outputs the display is too small, this will be indicated by "^^" at the right upper and "vv" at the right lower corner of the text. By pressing the keys   you may scroll up or down in the text.

5.2 Main Menu

The main menu automatically appears on the display after having started the **NetTEST II**.

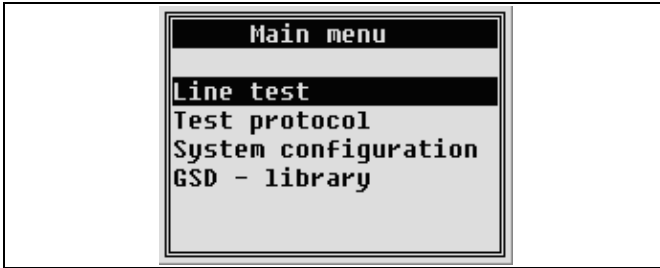

Figure 3: Screen 'Main menu'

The main menu comprises the following submenus:

- **Line Test**
 - **Test without PLC**
Stepwise check of cabling and test of DP Slaves, without protocol generation.
 - **PROFIBUS Master mode** (optional)
Set into operation of DP Slaves without PLC.
 - **Test with PLC** (optional)
Detailed analysis of the telegram traffic and the physical state of the PROFIBUS line.
- **Test Protocol**
 - **Test without PLC**
Like **Line Test – Test without PLC**, however, the results of all tests are stored in a test protocol for documentation purposes.
 - **Test with PLC** (optional)
Like **Line Test – Test with PLC**, however, the results of all tests can be stored in a test protocol for documentation purposes.
- **System Configuration**
For all device-specific settings.
- **GSD - library**
Submenu for the administration of GSD files.

5.2.1 Test without PLC

The menu *Test without PLC* serves for stepwise physical analysis of lines. This means that the test can be executed as often as desired. Some tests are based on the reference data of the preceding test, so that this one must be run beforehand. The individual items are interlocked, so that wrong operation is impossible. For tests run under this menu, no protocol is made out.

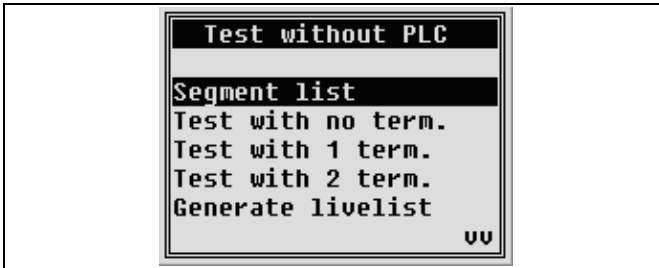

Figure 4: Screen 'Test without PLC'

For a line test, at first the design parameters for the PROFIBUS segment that has to be checked must be indicated. These indications are necessary, so that, e.g. the PROFIBUS DP specific measurements at the line segment may be executed with the real bus settings used in your plant. The settings are made in the submenu *Segment list*.

- ☞ As soon as a option is activated (DP Master or Online-Function), the *Line test* menu appears under *Test without PLC*.

5.2.1.1 Segment list

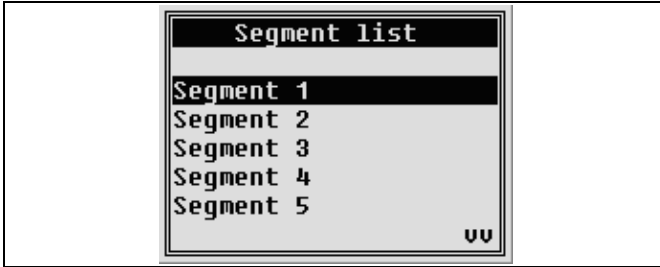

Figure 5: Screen 'Segment list'

Under *Segment list*, segment-specific data are stored serving as basis for the following measurements. The data are stored in the data base for line segments under the assigned segment name. From there, they can be used as basis for both individual tests and the creation of test protocols. Indications must be made as to the points listed below:

- Name of line segment (max. 30 characters)
- PROFIBUS baud rate (9.6 Kbit/s - 12 Mbit/s)
- PROFIBUS address for master operation of **NetTEST II** (0-126)
- PROFIBUS slot time tslot (300-5000)

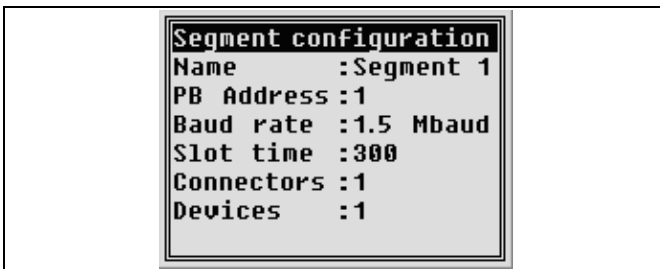



Figure 6: Screen 'Segment configuration'

The PROFIBUS baud rate, address and slot time are necessary for the parameterization of the installed PROFIBUS Master. With these settings, the tests *Generate livelist*, *Slave ident number*, as well as *Slave signal quality* are executed.

Moreover, indications regarding number of:

- Connectors (only number of 12 Mbit/s plugs!)
- Devices (all devices with PROFIBUS plug, or connected cable)

Connected devices and 12 Mbit/s PROFIBUS plugs considerable change by their inductivity resp. capacity the measuring abilities and characteristics for the **NetTEST II**. In order to keep these measuring insecurities in a tolerable scale, please indicate before each measurement the number of installed 12 Mbit/s plugs as well as the number of the devices connected to the bus. Please only indicate the plugs which dispose of incorporated direct-axis inductances. Devices stands for all units connected to a bus segment. This applies to Master and Slaves as well as to net components like segment couplers, repeaters, optical couplers etc.

Once the data are stored in the data base, they can always be used for new tests. The data in this data base cannot be deleted, only changed by overwriting. In order to have enough spare capacity for this function, 20 memory locations are available. The respective memory locations can be reached by actuating the  or the  key.

5.2.1.2 Test with no terminators

At the beginning of each test, the *Test with no term.* must be carried out. For this, the **NetTEST II** must be connected to one end of the PROFIBUS segment. Now the user makes sure that all bus termination resistors (terminators) in the bus segment are switched off resp. removed. Furthermore, no Master may send data via the bus. Then the *Test with no term.* can be carried out. If, by accident, a bus terminator or Master should be active in the segment, the **NetTEST II** recognizes and indicates this at once. Only if no more resistance in the thread is activated and all Masters are deactivated, the **NetTEST II** informs about:

- Line impedance
- Line length (segment length)

☞ Detections in segments with PROFIBUS plugs with a disconnection function can be tricky. If, e.g., in the middle of a segment, the terminator of such a plug is activated, the **NetTEST II** recognizes it, if it is measured from the entrance side. However, if the measurement is made from the other end of the plug, measuring is made into the open end and a cable length, shorter than the one expected, is indicated. Therefore please check very thoroughly if all bus terminators are switched off. Another possibility of finding such a plug is measuring from the other side of the bus.

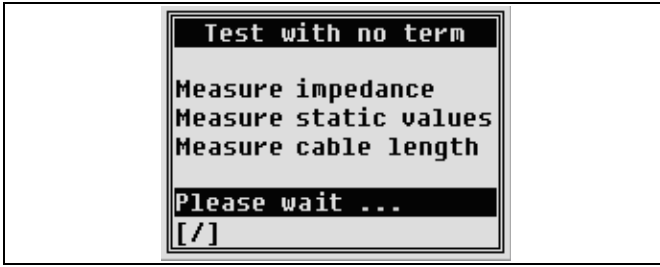

Figure 7: Screen 'Test with no term'

The ***Test with no term*** lasts for a few seconds. The duration depends on the cable length. To show the user that the system is still working, a star bar appears on the lower left hand side of the display as progress indication. Terminate the test with **←**. Upon conclusion the result will be displayed. Attention: If you quit the test with **ESC**, the ***Test with 1 term*** cannot be executed any more, as the just scanned data were deleted.

If no error is detected on the PROFIBUS segment, a "positive acknowledgement" message will appear, displaying the cable impedance and cable length according to the following figure.

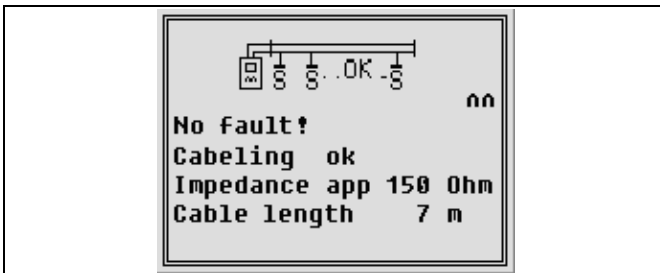

Figure 8: Screen after 'Test with no term'

The following error indications, that impede correct length and impedance measurement, may occur:

- *"No error: Impedance not detected"*: Cable length for the impedance measurement is too short.
- *"Error: No length measured"*: Cable length is either too short for length measurement or there is no cable connected.
- *"Error: A<->shield / B<->shield short circuit"*: There is a low ohmic resistance between signal wire and shield.

- *"Error: A<->B Short circuit or unpowered termination"*: There is a low ohmic resistance between the signal wires, which might be caused for example by a bus termination without power supply.
- *"Error: A<->B Irregularity, wrong termination or illegal termination "*: There is an unacceptable ohmic resistance between the signal wires, that stands in no relation to the magnitude of a bus termination either with or without power supply. The cause might be for example an incorrectly connected bus termination.
- *"Error: A<->B Terminator"*: There is a powered bus termination (possibly along the line), which impedes impedance and length measurement.
- *"Error: A<->shield / B<->shield high imp. fault"*: There is a high ohmic resistance between signal wire and shield.
- *"Error: A<->B Capacitive load, junction or Impedance changes"*: There is a capacitive resistance between the signal wires, which might be caused by a PROFIBUS device with unauthorized bus coupling, a branch or switch over to a inadmissible cable type.
- *"Error: Possible broken line of shield / of signal line A/B distance XX m"*: Result of the length measurement is significantly different for the various lines and shields.
- *"Error: uncertain situation / possibly broken line of shield or of signal line A/B. Please repeat measurement at the opposite segment-end"*: Result of the cable length measurement for the various different lines and shields is so different, that no specific statement about the respective line segment is possible. Should the measurement on the other line end give correct results, then the measurement may be considered o.k. In particular, this effect may be observed with cable coils or cable drums in the PROFIBUS network.

With each of these error messages there may be an indication of a distance. Some errors (e.g. invalid termination) do not give conclusive information about the distance.

Moreover, all error messages may also include the indication "*uncertain error*". This may be indicated, if the cause of the error could be detected only roughly, thus permitting only an error estimation.

- ☞ Also with uncertain error situations, the PROFIBUS segment has problems in any case, even if the measured error is relatively small. Due to EMV and high baud rates (≥ 1.5 Mbit) this may lead to severe communication problems.

An effective method for determining errors in their position is to divide the segment into several sub-segments, and to submit them to separate examinations.

- ☞ All error indications are also displayed with the **F1** key.

5.2.1.3 Test with 1 terminator

Prior to the *Test with 1 term.*, in any case the *Test with no term.* must be completed. If this was not made, the user is being informed about this and can immediately make up for this test. For the *Test with 1 term.*, the terminator at the bus end opposite to the NetTEST II must be switched on and set under current. With a DP Slave unit or another passive bus participant, the plug can be connected directly, the terminator added and the unit switched on. If the unit at the end of the line segment is a PROFIBUS Master, take care that the bus participant does not actively send data onto the bus. This can e.g. be realized by a bus disconnector. Via the bus disconnector, the bus terminator in the PROFIBUS plug is supplied with power, but the bus line is interrupted by a mechanical switch in direction to the line segment.

Upon conclusion of the test the result will be displayed on the screen.

If no error is detected with the *Test with 1 term* on the PROFIBUS segment, a "positive acknowledgement" will appear, according to the following figure.

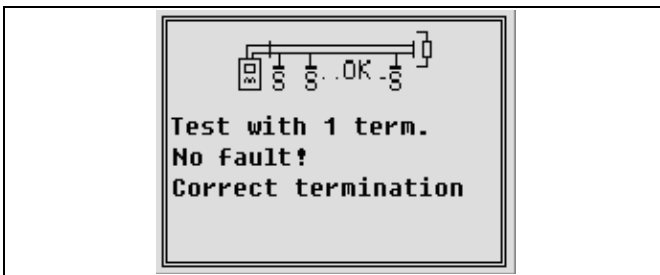



Figure 9: Screen after 'Test with 1 term.'

In case of errors, the following error messages may be displayed:

- *"Error: no termination or switch defect"*: No valid termination could be detected.
- *"Error: Your terminator is not at the far end of the segment !"*: Contrary to the instruction the terminator was switched at the near segment end.
- *"Error: A<->B twisted"*: Mix up of signal lines.
- *"Error: A<->shield / B<->shield short circuit "*: There is a low ohmic resistance in the cable between signal wire and shield.
- *"Error: A<->B short circuit or bus terminal without power supply"*: There is a low ohmic resistance in the cable between the signal wires.
- *"Error: A<->B Irregularity, Wrong termination or illegal termination"*: There is an inadmissible ohmic resistance between the signal wires, that stands in no relation to the magnitude of a bus termination either with or without power supply, for example caused by a wrongly connected bus termination.

The **Test with 1 term.** must also be terminated by the  key in order to be able to execute the following test.

5.2.1.4 Test with 2 terminators

Following the *Test with 1 term.*, the *Test with 2 term.* is started. Here it is checked if the bus terminator at the line end of the **NetTEST II** was switched on additionally. For this test, the terminator must also be supplied with power. This can easily be done from the last unit in the segment. If this should be a Master which cannot be made passive, the data line has again to be disconnected from the segment via a bus disconnecter.

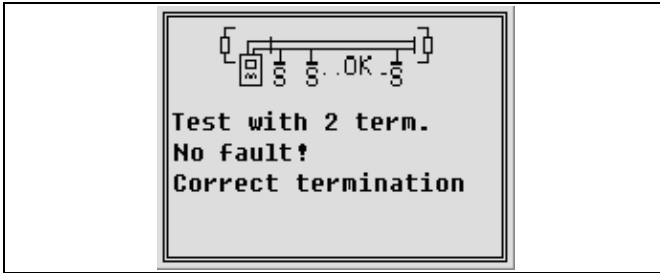

Figure 10: Screen after 'Test with 2 term.'

If the *Test with 2 term.* was terminated successfully, it can be taken for granted that the cabling in the segment was done correctly. If during the test with **NetTEST II** an error should have been detected, this would be depicted on the display by a graphic and text indication.

Possible error messages are described in detail in chapters 5.2.1.2 and 5.2.1.3

5.2.1.5 Generate livelist

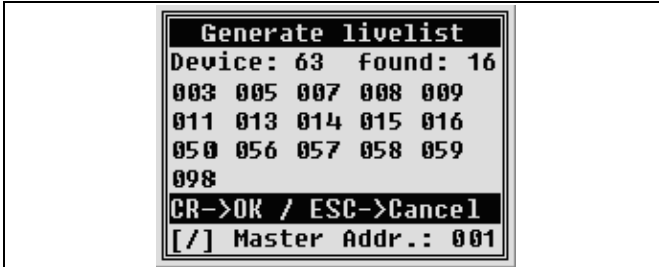

Figure 11: Screen 'Generate livelist'

In the menu *Generate livelist*, NetTEST II scans all possible bus addresses from 0...126 for PROFIBUS DP Slave participants. For this, a FDL request is effected several times on each address. If a device answers with *OK*, its bus address appears on the display. The unit counter is incremented by one. To ensure that also extremely slow units are recognized, the test takes approx. 30 seconds. Should all connected units already be recognized, the user can truncate the test with . Should there be more units than depictable on one display screen, the user can scroll through after the test with keys.

To be able to execute further tests, *Generate livelist* must by all means be terminated by . Only then the recognized units are registered in the internal memory, so that for these in the following test, a *Slave_Diag_Req* can be run. If the test is quit by , no slave diagnosis can be executed afterwards!

5.2.1.6 Slave ident number

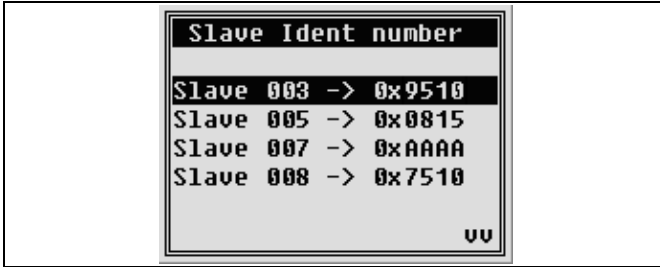

Figure 12: Screen 'Slave ident number'

Via the *Slave ident number* menu, the Ids for a better assignment of the DP Slave addresses to the unit type can be indicated. Here, a *Slave_Diag_Request* is executed on the respective device, and this returns in its answer the ident number. This will then be indicated behind the Slave address.

5.2.1.7 Slave signal quality

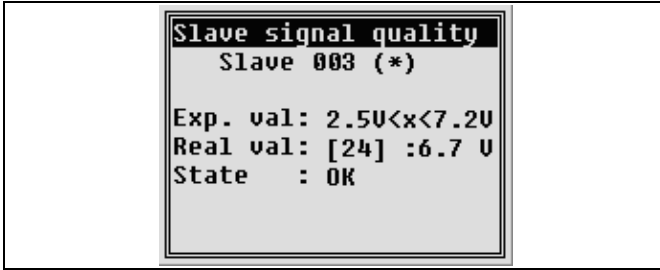

Figure 13: Screen 'Slave signal quality'

With the *Slave signal quality*, the signal level of the addressed DP Slave is measured. This should be with an impeccable unit and correctly terminated bus and a cable length of 1 m from the measuring point to the Slave at approx. 6.3 Volt. Per 100 m more cable between **NetTEST II** and the device to be scanned, the level reduces by approx. 0.2 Volt.

U < 2.5 V: Weak level or no longer detectable.

2.5 - 7.2 V: Level is ok.

U > 7.2 V: If the indicated level is >7.2 Volt, this is an indication for a faulty power supply of the Slaves or for reflections at the bus.

5.2.1.8 Baud rate detection

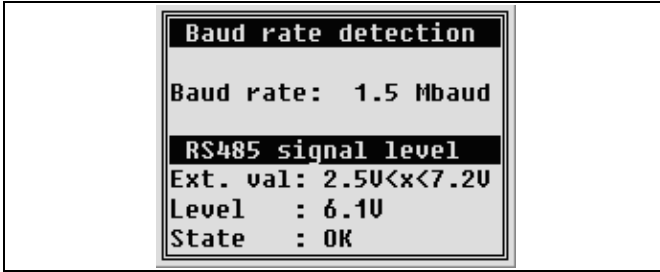

Figure 14: Screen 'Baud rate detection'

With the menu point ***Baud rate detection*** a running bus with active Master is monitored and the current baud rate is indicated. During this baud rate scan, the general signal level at the bus is being measured analogous to ***Slave signal quality*** (see chapter 5.2.1.7). Here the user receives immediately and without needing an oscilloscope an indication as to existing reflections at the bus, or if the detected level is too weak. Here, the level is also indicated in Volt and a status is indicated.

- ☞ If the Online-Function is activated, the menu ***Baud rate detection*** appears under ***Test with PLC*** (see chapter 8.1).

5.2.2 Test protocol

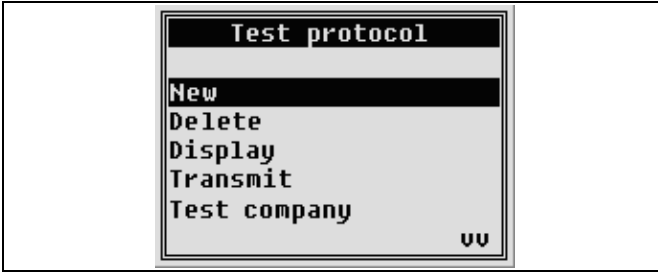

Figure 15: Screen 'Test protocol'

Test protocol serves for creating measuring protocols needed for documentation purposes. In addition to the test data, the user has the possibility to define plant-specific data like plant name, line segment name, customer data for the test protocol.

5.2.2.1 Create new protocol

In the menu *Create new protocol*, all steps necessary for the test protocol are executed successively. The tests are run in the following order:

- Select user name from *User list*
- Select customer name from *Customer list*
- Select plant name from *Plant list*
- Select segment name from *Segment list*
- Selection menu 'Test protocol' (only with option Online-Function)

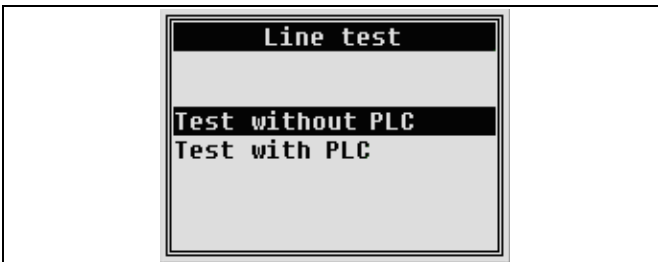

Figure 16: Selection menu 'Test protocol'

5.2.2.1.1 Test without PLC

Contrary to individual measurements, the test order instructed by the **NetTEST II** must be considered. The cable tester always instructs the user how to perform the next test. If a test fails it can be repeated as long as the problem is fixed. The failed test is only stored in the test protocol if the protocol compilation is canceled at this point.

☞ By means of the **↵** key the single test is confirmed and the protocol compilation continues. By means of **ESC** key the protocol compilation is canceled.

5.2.2.1.2 Test with PLC

The test protocol compilation for the test with PLC is only available with the option Online-Functions.

Contrary to the Test without PLC no test order must be considered. All performed tests will be stored in the test protocol. If a test is repeated only the last test result will be stored. By the **F2** key the test protocol compilation is finished and the results are stored

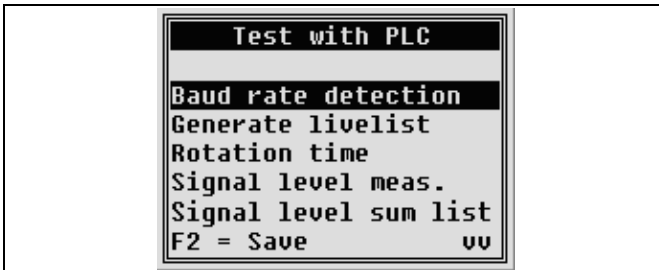







Figure 17: Screen 'Test protocol with PLC'



5.2.2.2 Delete

With this menu you can delete existing test protocols from the database. This should only be done if the corresponding protocol was sent to a PC via a serial interface, or if the protocol is no longer needed.

5.2.2.3 Display

Stored test protocols cannot only be displayed on the PC, but also be displayed again with this function. Here, the display is analogous to the display during measurement. To go through the individual screens, please use the  key. If the contents needs more space than available on the display, you can scroll the screen window with     keys.

5.2.2.4 Transmit

The test protocols are stored under the plant name and furthermore under the segment name. If there should have been made several tests in the same segment, these can be distinguished due to the test date and time. Select the segment you want to send to the PC by the   keys, and confirm with . For the settings to be made at the PC, please see chapter 6.3.

5.2.2.5 Test company

In this menu you can enter your company name. The data entered are issued in the test protocol.

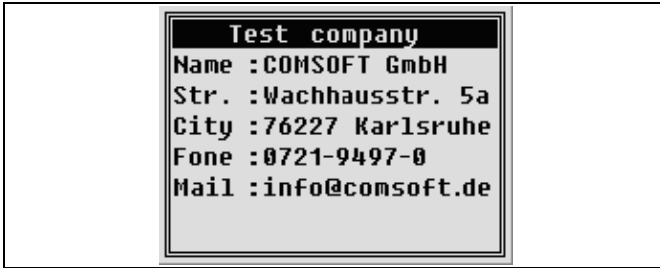

Figure 18: Screen 'Test Company'

5.2.2.6 User name list

Here, the names of all users can be stored in a data base with 10 memory locations. This saves time in case of multiple test for a renewed indication in the test protocol. At the corresponding place, the user name can be selected by simply using the **↑** **↓** keys when issuing a test protocol. The indication is made in alphanumeric order via keyboard (see chapter 12). The name length is limited to 40 characters.



Figure 19: Screen 'User name list'

5.2.2.7 Customer list

The entry of customer data is made analogous to the entry of the test company (see chapter 5.2.2.5). Here, a list with max. 10 customers can be created. The entries can be made before executing a test. This saves time at the customer's site.

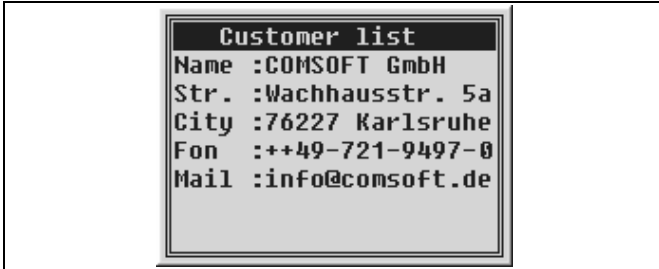

Figure 20: Screen 'Customer list'

5.2.2.8 Plant list

In order to have a reference to the plant name where the tests were made, the plant name can be entered here. The name length is limited to 40 characters. The maximum number of plant names is 10.



Figure 21: Screen 'Plant List'

5.2.2.9 Segment list

The submenu *Segment list* has, under *Test protocol*, the same task as the menu point under *Line test*. The functionality is therefore analogous to the one described in 5.2.1.1.

5.2.3 System configuration

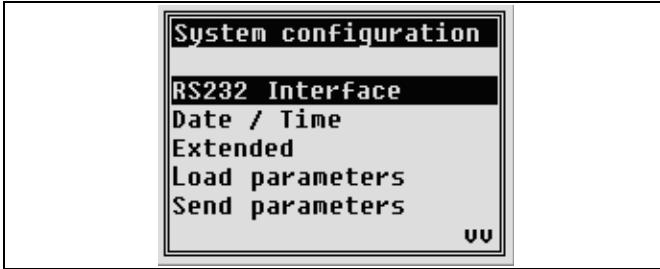

Figure 22: Screen 'System configuration'

System configuration is for device specific settings, like e.g. parameterization of the serial interface, time settings, firmware update and extended parameters. Here, also settings like turn on / off key signal, automatic switch-off time of the tool, illumination time for the background illumination of the screen, and language selection for the screen text.

5.2.3.1 RS232 Interface

The built-in serial interface serves for a data exchange with a PC. On the PC side, a terminal program is needed. For a data exchange between **NetTEST II** and the terminal program (e.g. Hyper Terminal, Hilgraeve, part of Microsoft operating systems), the interface parameters like baud rate, number of data bits, parity, number of stop bits and the used protocol must coincide. The settings are needed for the menu points 5.2.2.4, 5.2.3.7 as well as 5.2.4.2. For the settings on the PC side, please see chapter 6.

5.2.3.2 Device properties



Figure 23: Screen 'Device properties'

With the menu *Device properties* the version and serial number is displayed. Additionally the options DP Master and Online functions can be activated if the appropriate license code is available.

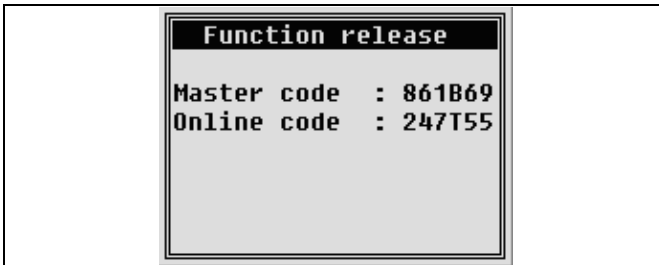



Figure 24: Screen 'License code'

If a wrong license code is entered and confirmed with the  key the indicated license code changes to "-----".

5.2.3.3 Date / Time

To furnish the test protocols with time and date indications, **NetTEST II** is equipped with a quartz clock. In the submenu **Date / Time**, the clock can be set.

The quartz clock is fed from the battery. If this battery should be empty or removed, the clock is energized by a maintenance-free capacitor. This capacitor provides the clock with energy for about 2 weeks. If within this period of time the battery pack is not charged, time settings are lost. If this case should arise, the user is advised that, when turning on the tool the clock has to be reset.

5.2.3.4 Basic parameters

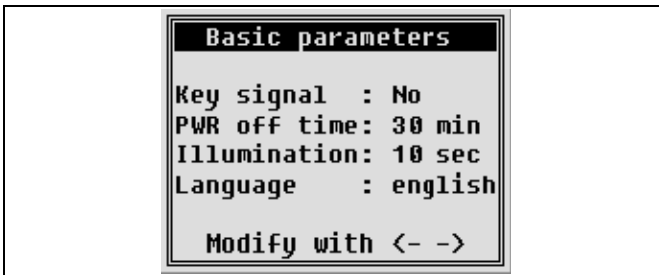



Figure 25: Screen 'Basic parameters'

5.2.3.4.1 Key signal

The **NetTEST II** is equipped with a loudspeaker. If the key signal is turned on, each key pressing is confirmed with an acoustic signal. This can be activated or deactivated by the

  keys.



5.2.3.4.2 PWR off time

To save battery power, **NetTEST II** can be programmed by the **PWR off time** function with a time, after which the tool switches off automatically. The selection is made by the   keys.

The character '~' in the selection means, the system does not shut down.

- ☞ For the creation of test protocols in large plants, the off-time should be set to 30 min., to make sure that e.g. test results of the **Test with no term.** needed for the following **Test with 1 term.** will not get lost by an untimely switch-off of the tool.

5.2.3.4.3 Illumination



With **Illumination**, the   keys serve for setting the period of screen illumination time after the last key touch. If not absolutely necessary, we recommend to turn it off due to the higher current consumption.

The character '~' in the selection means the system does not turn off the background lighting.

5.2.3.4.4 Language

You can select between two languages for the display screen:

English and German

Setting again via the   keys

5.2.3.5 Load parameters

In the submenu *Load parameters* the user can receive parameter data sets from the PC. (see chapter 6.4 for procedure)

The parameter data set comprises all parameters that are or may be set by the user of the **NetTEST II**.

- General parameters
- Customers
- Test persons
- Plant
- Segments
- Test company
- GSD - definitions

Additionally will be stored (for systems with Master Option):

- Master – Parameter
- Slave – Parameter
- Tag – Definitions

5.2.3.6 Send parameters

In the submenu *Send parameters*, the parameter set of the **NetTEST II**, format as described in chapter 5.2.3.5 (Load parameter), can be transmitted to the PC and saved. (see chapter 6.5 for procedure)

- ☞ In order to expand / modify the parameter set, it is recommended to load the existing parameter set onto the PC, to modify and save it there and to eventually back load it onto the **NetTEST II**.

5.2.3.7 Firmware update

The submenu *Firmware update* enables you to load possible firmware updates onto the test tool **NetTEST II** (see chapter 6.4).

A fully charged accumulator is to be used, as the update process must not be interrupted. With a transition rate of 19.200 Baud the process takes approx. 12 min.

5.2.4 GSD - library



Figure 26: Screen 'GSD - library'

The *GSD - library* serves for the exchange of GSD files from the PC to the **NetTEST II** as well as for storing certain GSD contents. Should the GSD files of the devices connected to one segment be stored on the **NetTEST II**, a reference between *slave_ident_number* and the device name can be made. It is possible to store up to 128 GSD file content on the **NetTEST II**.

5.2.4.1 New File



It is not obligatory to load the GSD file onto the **NetTEST II**. You can as well enter settings like device name, slot time and ident number directly via the keyboard and store them in the data base.

5.2.4.2 Receive GSD File



To prepare reception of GSD files sent from a PC, the following steps must be performed:

- Start your terminal program on your PC
- Settings of the terminal program analogous to settings of **NetTEST II** (see chapter 5.2.3.1 and 6)
- Connection of **NetTEST II** and the PC via the attached serial cable connector
- Prepare **NetTEST II** for reception of GSD file (***Receive GSD File***)
- Then select by means of the function *Send file* of the terminal function, via the available browser, the GSD file and send it by means of the protocol setting “Kermit” to the **NetTEST II**.

5.2.4.3 Delete GSD File

Delete GSD File serves for the deletion of GSD contents no longer needed. Selection is made by means of the   keys.

5.2.4.4 Display / Edit

To gain an overview over the already existing GSD files in the data base, the contents can be viewed via ***Display / Edit***. Selection by means of the   keys.

6 Communication with a PC

The communication with a PC for the functions *Receive GSD File* (see chapter 5.2.4.2), *Load / send parameter data set* (see chapter 5.2.3.4 and 5.2.3.5), *Firmware Update* (see chapter 5.2.3.7) and *Send Test Protocol* (see chapter 5.2.2.4) is made by means of a terminal program via the PC's COM interface. With the Microsoft operating systems Windows 3.x, 95/98/NT/2000/XP it is the HyperTerminal made by Hilgraeve, which is part of delivery. Below please find the necessary settings for the communication with **NetTEST II**.

6.1 Characteristics of HyperTerminal

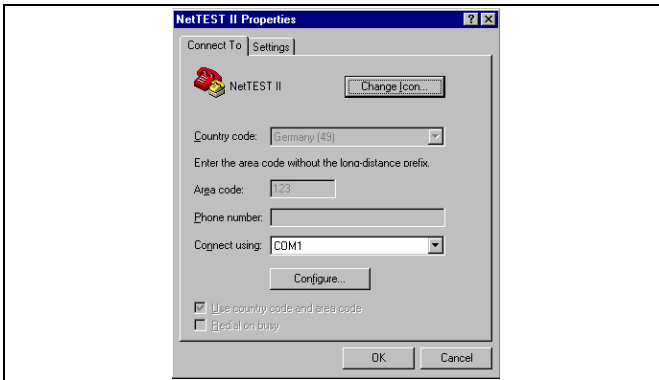

Figure 27: Connection Setting via COM1

After having started HyperTerminal, the connection must be made directly to one of the PC's serial interfaces via *File-Properties*. These are usually COM1 or COM2. If available, any other free COM interface can be used.

6.2 COM Interface Configuration

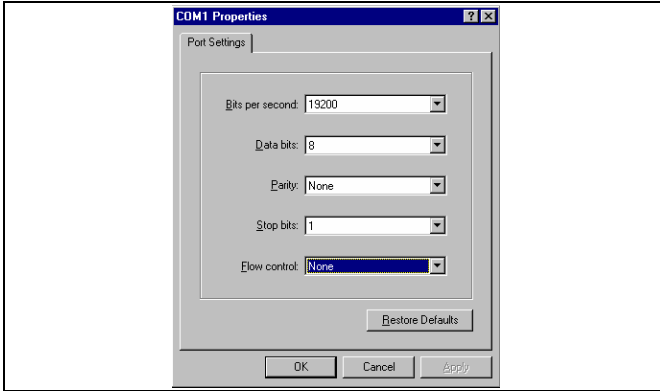

Figure 28: Characteristics of the serial interface

The interface set under 6.1 must now be configured. To make transmission as fast as possible it is recommended to adjust the max. serial baud rate of **NetTEST II** to 115200 Baud. The setting of data bits, parity as well as stop bits is made analogous to the settings of **NetTEST II** (see chapter 5.2.3.1). As **NetTEST II** does not support a hard- or software handshake, please select under the point *Flow control* – ‘None’.

No further settings have to be made at the terminal program. Now it can be stored with File – *Save As* as a standard file for the communication with **NetTEST II**.

6.3 Receive Test Protocol

To receive a test protocol from **NetTEST II** please proceed as follows:

- Connect **NetTEST II** via the cable connector, included in the delivery, with the COM interface defined in the terminal program.
- Start the configured terminal program on your PC.
- In your terminal program, click on *Transfer-Capture-Text*
- In the browser opening now enter the directory where you wish to save the test file. Also, indicate the file name for the test protocol. Now click on *Start*.
- Start the transmission from **NetTEST II** to the PC (see chapter 5.2.2.4).
- When the transmission is finished, the terminal program must be closed with *Transfer-Capture Text-Stop* .

6.4 Send File to NetTEST II

There are three kinds of files you can send to the **NetTEST II**: e.g. GSD files, parameter data sets and firmware updates. Follow the procedure below:

- Connect **NetTEST II** via the available serial cable connector with the COM interface defined in the terminal program.
- Start the configured terminal program on your PC.
- In the terminal program click on *Transfer-Send file*
- Indicate in the browser opening now the directory where the file to be sent is stored. Set the transmission protocol to *Kermit*.
- Set **NetTEST II** to *ready for reception* in the corresponding menu, either for *Firmware Update* (5.2.3.7) or *Receive GSD File* (5.2.4.2).
- Start the transmission from your PC to **NetTEST II** (*Send with HyperTerminal*).

☞ The firmware update may not be interrupted. Therefore please plug in a new battery in the **NetTEST II**. The whole procedure takes approx. 12 min. with a set baud rate of 19.200 Baud.

6.5 Send file from NetTEST II to the PC

In order to, e.g. save parameter sets, data must be able to be sent from the **NetTEST II** to the PC. In this case, proceed as follows:

- Connect **NetTEST II** via the serial connection line (included in delivery) to the COM interface set in the terminal application.
- Start the previously configured terminal application on your PC.
- Click on Transmission - File receive... in the terminal application.
- Enter the directory over the subsequent browser, where the file to be received is to be saved. Set the transmission protocol to Kermit.
- Start the transmission receive in the PC (e.g. Receive button in the Hyper Terminal Dialogue).

Start the receive command in the corresponding menu in the **NetTEST II**.

7 Systems with PROFIBUS Master Option

Option

Systems featuring the PROFIBUS Master Option can be differentiated by their modified "PROFIBUS" screen start-up logo, depicted below.



Figure 29: "Start-up" Screen with the PB-Master

The PROFIBUS Master Options are summarized in an additional menu item contained in the Line Test menu. No protocol is drawn up for the tests under this menu item.

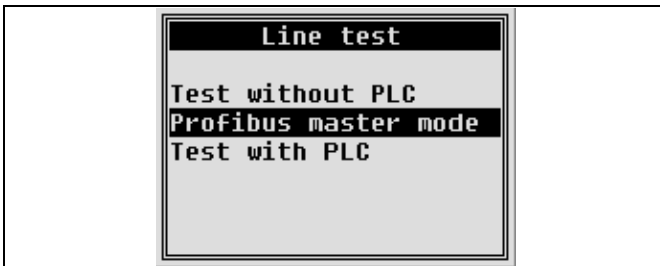

Figure 30: Screen 'Line test'

The **NetTEST II** offers you the complete functionality of a PROFIBUS DP-MONO-Master with extended diagnostic functions. DP-MONO-Master stand for the fact that the **NetTEST II** cannot share the bus with other Masters.

For reasons of clarity the **NetTEST II** processes only **one** of the DP Slaves on the PROFIBUS at a time.

The PROFIBUS Master Option is divided in 2 different modes:

- A “simple“ user mode to check the problem free communication with the connected Slaves.
- An extended user mode, where all Slave parameters can be changed or modified.

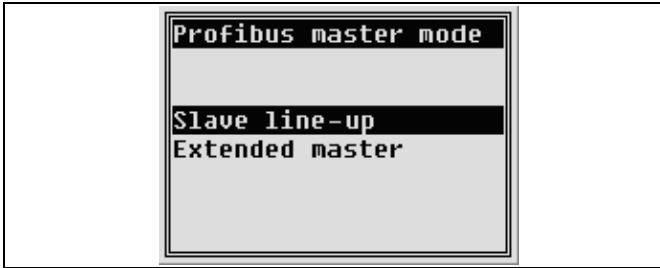

Figure 31: Screen 'PROFIBUS Master mode'

7.1 Slave line-up

Before using *Slave line-up*, **NetTEST II** needs a valid Slave configuration. This can be done either by creating and downloading a configuration via the **COMSOFT Konfigurator-Tool** or by creating the configuration directly on **NetTEST II**.

Entering "Slave Line-up" launches the Slave selection menu, where the Slave to be tested can be selected

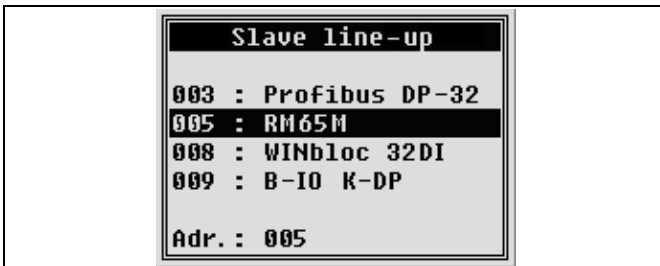

Figure 32: Screen 'Slave line-up'

After the selection of the Slave to be tested the operation dialogue is launched and the DP Master starts the DP State-Machine to get the Slave into operation.

The actual communication state of the Slave is displayed in the last line of the display.

Possible messages:

- **"no response"**
There is no response from the selected Slave (e.g. the PROFIBUS address is wrong or the Slave is disconnected)
- **"in operation"**
The Slave is working properly, input and output data are transferred.
- **"in operation !"**
The Slave is working properly and reports external diagnostic data. By selecting the menu *Read Diagnostic Data* the diagnostic data can be read from the Slave and the '!' in the display is reset.
- **Other messages**
The Slave is connected to the bus but the param- or config-data are not correct and the Slave cannot be set into "in operation" state.

If the Slave reaches the state "in operation" output data can be modified and input data can be displayed.

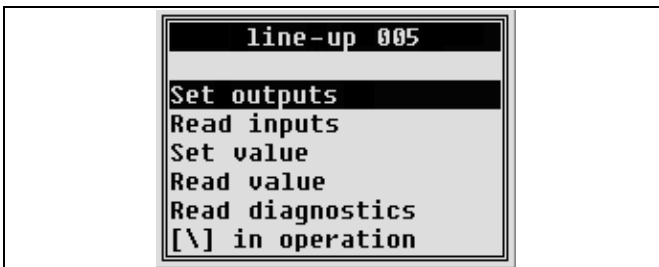

Figure 33: Screen 'Slave line-up'

7.1.1 Set outputs

The output data of the Slave can be modified as described in chapter 7.2.5.1.3.

7.1.2 Read inputs

The input data received from the Slave are displayed. Modifying of this data is not possible.

7.1.3 Set value

Output values are an extraction from the output data stream of the Slave. With output values it is possible to access for example a digital output or a analogous real value directly. Output values are defined via tags in the DP Master-configuration.

☞ This can be very helpful especially if REAL values are processed with the Slave

7.1.4 Read value

Input values are an extraction from the input data stream of the Slave. With input values it is possible to examine for example a digital input or a analogous real value directly. Input values are defined via tags in the DP Master-configuration.

7.1.5 Read diagnostics

Reads the diagnostic data of the Slave and shows a decoded representation.

Not read diagnostic data are shown by an additionally “!” in the status message of the Slave, e.g. “in operation!”. With reading the diagnostic data the “!” is deleted from the status message.

7.2 Extended master

The *Extended master* option can be subdivided into four partial units listed in the following depiction:

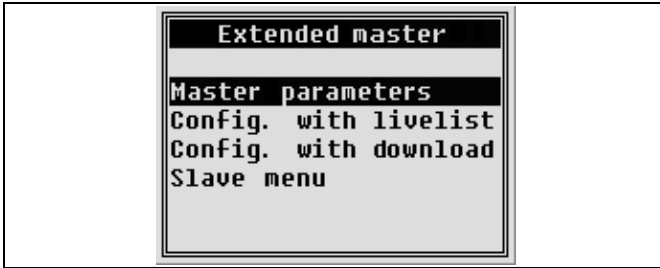

Figure 34: Screen 'Extended master'

The **NetTEST II** stores the configuration of up to 32 Slaves. Moreover, the segment configuration (bus address, baud rate and slot time) can be downloaded from the **COMSOFT-Configurator** to the **NetTEST II**.

7.2.1 Master parameters

The menu *Master parameters* will lead you to another menu selection, where you have the option of either viewing or modifying the PROFIBUS segment parameters, or setting the PROFIBUS Master parameter by selecting pre-defined segments.

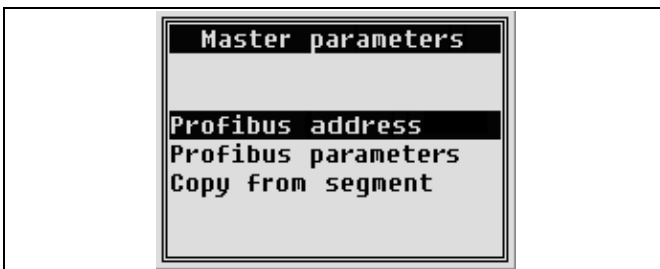

Figure 35: Screen 'Master parameters'

7.2.1.1 PROFIBUS Address

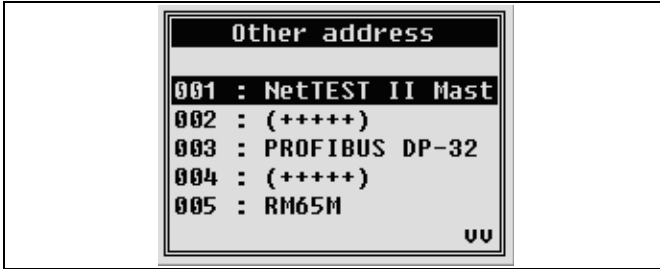

Figure 36: Screen 'Other address'

From the address menu an entry may be selected, that is not in use by another PROFIBUS device. This is marked by (+++++) in the address selection menu. (each device at the PROFIBUS segment has to have his own individual address).

7.2.1.2 Profibus parameters

By choosing this option, the PROFIBUS Master parameters of the **NetTEST II** are displayed.

Modifications are done by entering new parameters and subsequently pressing the  key.



Figure 37: Entry mask 'Master configuration'

7.2.1.3 Copy from segment

The Master parameters may also be set by choosing one of the pre-defined segments. The PROFIBUS segment definition contains all necessary parameters for the configuration of the **NetTEST II** as the PROFIBUS Master.

See also chapter 5.2.1.1 for more information on segments.

7.2.2 Config. with livelist

By means of *Config. with livelist* the user has the option of making a configuration using the current Slaves from the segment. The bus configuration is, however, incomplete, i.e. all parameters have to be modified subsequently. Moreover, tag definitions of the process image may not be edited.

The user has to confirm the creation of the livelist, as a possible configuration may be deleted.

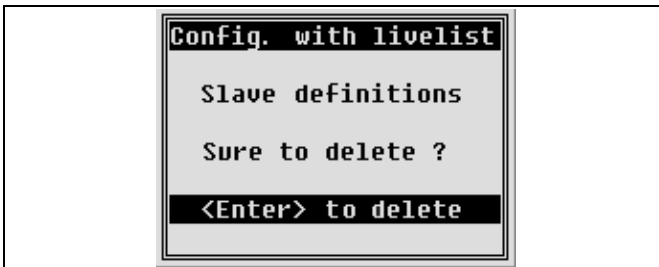

Figure 38: Screen 'Config. with livelist'

The detected Slaves are entered into the configuration for the Master.

7.2.3 COMSOFT Configurator Tool

By means of this tool the user can create complete PROFIBUS segment configurations, inclusive all bus parameters and tag definitions.

7.2.3.1 Creation of a configuration

- Copy the GSD files of all used PROFIBUS Slaves into to sub-directory "GSD", below the installation index of the **COMSOFT Configurator-Tool**. The Configurator needs these for the configuration of the DP Slaves.
- Start the **COMSOFT Configurator**. The Configurator will depict a double-window. The left half of the window displays the configuration in the form of a tree-like structure. The right hand window displays the characteristics of the selected element.
- Choose "NetTEST Master" in the context menu. The context menu can be accessed over the right mouse button, when selecting the root element of the tree-like structure.

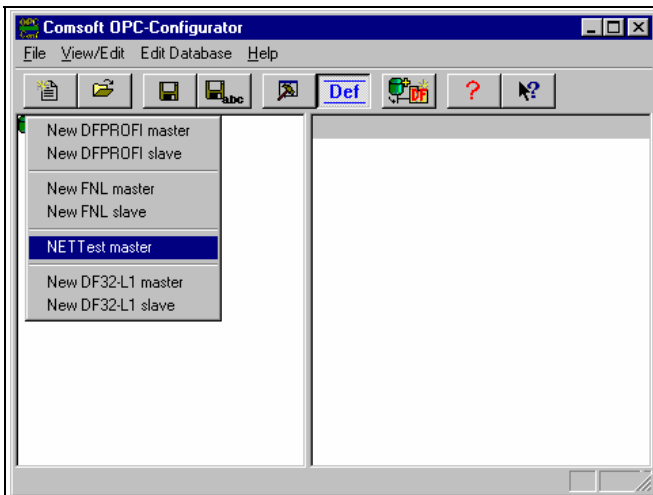

Figure 39: Screen 'context menu in the *Configurator*'

- Select the PROFIBUS address, baud rate and slot time in the "NetTEST Master" dialogue.
- Select a new Slave over the context menu of the "NetTEST Master". The context menu of the "NetTEST Master" can be accessed by pressing the right mouse button, after selecting the "NetTEST Master" element of the tree-like structure.
- Select the GSD of the Slave that is to be newly created from the file dialogue. The Slave Configuration menu subsequently displayed enables the user to configure the bus subscriber (if supported by the GSD file) parameter data, module definitions, as well as module parameters. Details to the Slave configuration may be found in the *Configurator* Online-Documentation.

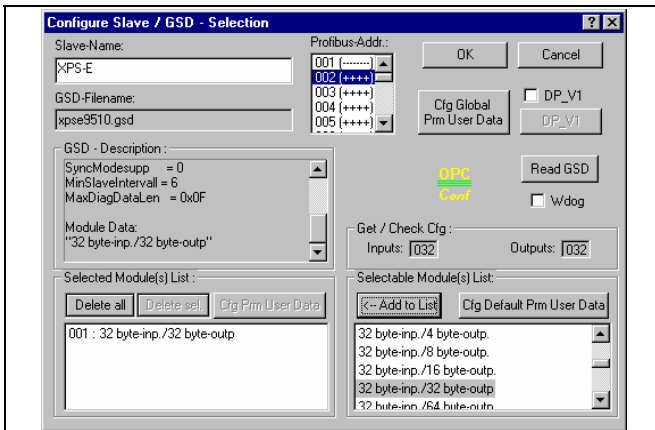

Figure 40: Slave-Configuration Dialogue

- Multiple Slave definitions may be created by repeating the last steps several times over.
- Choose the option "New tag(s)" on the context-sensitive menu of the newly generated slave. This menu may be opened by pressing the right mouse button, provided that the slave is selected from the tree-like structure.

- Create "tag(s)" over the dialogue by choosing from the tag properties and confirm by subsequently pressing the "Add tag" button. In order to create several "tag(s)", this transaction may be repeated several times over.
- Upon completion of the configuration save the entire configuration under a unique configuration name.

Additional documentation relating to the **COMSOFT** *Configurator-Tool* may be found in the Online-Documentation of the *Configurator*.

- ☞ Should the user possess a PROFIBUS Master card or FNL from **COMSOFT**, then the configuration may be checked in advance by setting to a DF PROFI or FNL-Master by means of the "Test / change (Expert mode)", and subsequently be converted to a **NetTEST II** Master for downloading.

7.2.4 Config. with download

By means of *Config with download* the user may download the configuration file from the *Configurator* to the **NetTEST II** via a download dialogue.

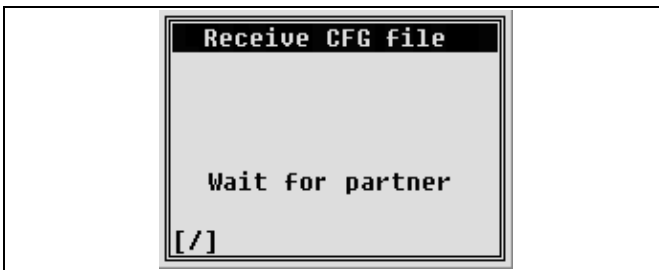

Figure 41: Screen 'Receive CFG file'

The user reaches the download dialogue via the context menu of the "NetTEST Master" in the *Configurator*.

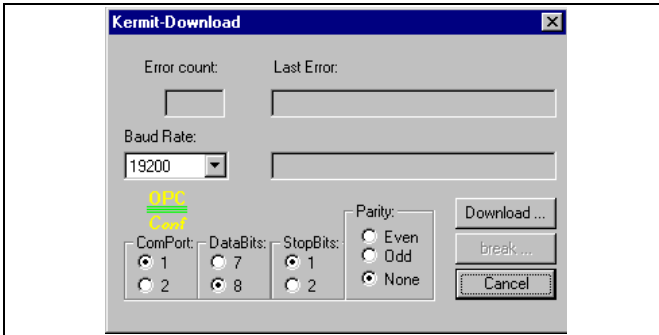

Figure 42: Download *Configurator-Tool* dialogue

Was the configuration download performed successfully, then, with the **NetTEST II**, the received configuration has to be confirmed by pressing the **↵** key.

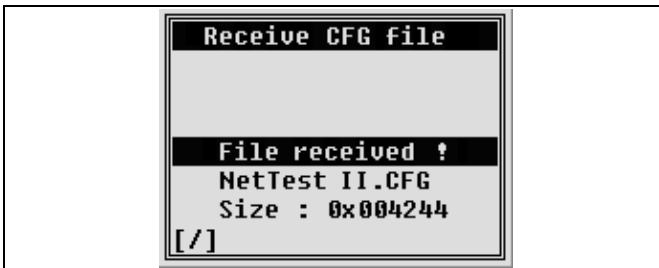

Figure 43: Confirmation Screen 'Receive CFG file'

Word of caution: An existing configuration is only overwritten, if this action is confirmed by pressing the **↵** key. Is the **ESC** key pressed instead, the newly loaded configuration is discarded and the original status of the Master configuration is maintained.

7.2.5 Slave menu

In the *Slave menu* the user has the possibility to add or remove Slaves to / from the configuration, to check or reset all configuration settings, to reach the Slaves via PROFIBUS services or activate them by means of the **NetTEST II**.



Figure 44: Screen 'Slave menu'

7.2.5.1 New Slave

By choosing this option, the user can newly define an additional Slave to the existing configuration.

7.2.5.1.1 New address

At the start of the creation process, the user needs to select a new PROFIBUS address. (Each subscriber at the PROFIBUS segment has to possess his own individual address).



Figure 45: Selection menu 'New address'

A new Slave address has to be selected in the address selection menu. Available PROFIBUS addresses are marked with (+++++).

In order to complete the definition of a new Slave, three more forms need to be completed.

Each of these dialogues is to be concluded with pressing the **←** key. If, at any time, the **ESC** key is pressed, then the creation process for the Slave is interrupted, and all entries made up to this point are discarded.

7.2.5.1.2 Parameter

General Slave parameters are to be entered in the first dialogue. The parameters are needed for all PROFIBUS Slaves. The Slave name is needed for further referencing within the **NetTEST II**. The other parameters are standard parameters for the Set_Prm_Req and can be retrieved from the appropriate GSD file (Gerätstammdatei).

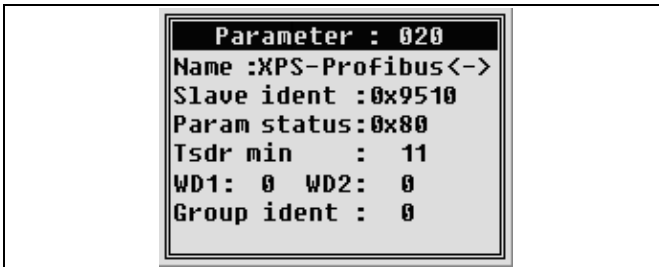

Figure 46: Entry mask 'Parameter'

7.2.5.1.3 User prm

The second mask shows the User Param data for the Set_Prm_Req. The user can enter the size of the User Param data in the bottom line. By pressing the **←** key the user will then reach the entries of the (Hex)values. By pressing the **F2** key, the entry mode can be switched from hexadecimal entry to ASCII entry. The user can return to the hexadecimal entry by pressing the **F1** key. If the data bytes are to be changed, the numeric entry may be accessed by pressing the **F3** key. This is confirmed by the **←** key.

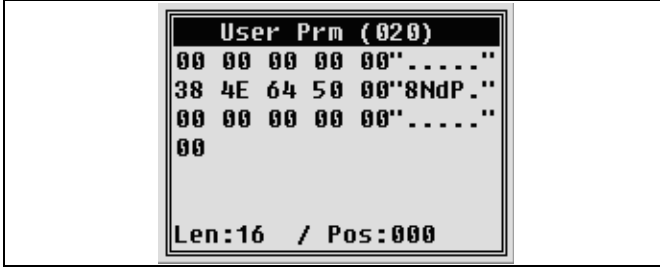

Figure 47: Entry mask 'User prm'

7.2.5.1.4 CFG Data

The third mask shows the configuration data for the Chk_Cfg_Request. Operation runs analogously to operation of the UserParamData entry dialogue.

Entry of the Slave definition is concluded once this dialogue has been successfully filled out.

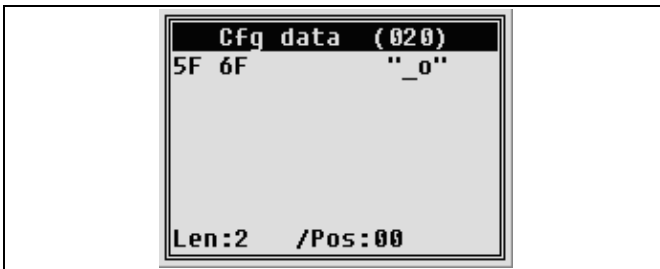

Figure 48: Entry mask 'Cfg data'

Note: Creation of a PROFIBUS configuration can be performed much easier with the aid of the *Configurator-Tool*, as it is capable of evaluating GSD files directly and creating a Slave configuration without the deep knowledge of the details.

7.2.5.2 Copy Slave

This option enables the user to generate a 1:1 copy of an existing Slave configuration. All related tag definitions are included in the copy (see chapter 7.3.1.5 DPTag definitions).

In the first step, the user has to select from the list of existing Slaves the one that is to be duplicated.

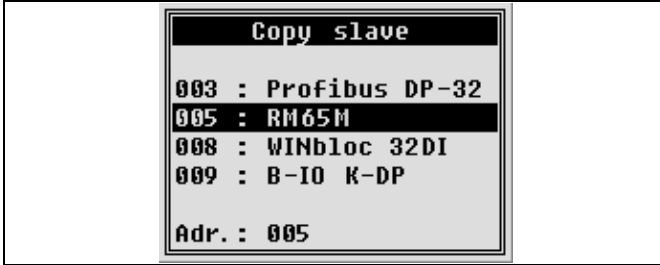

Figure 49: Selection menu 'Copy slave'

Upon selection of one of the listed Slaves, the user has to choose a new PROFIBUS address for the copy. (Each subscriber at the bus segment has to possess his own individual address).

The address selection takes place by means of the address selection menu. (see chapter 7.2.5.1).

Further entries are not necessary for generating a Slave copy.

7.2.5.3 Delete Slave

Selection of a Slave to be deleted takes place analogously to the selection of the Slave to be copied in chapter 7.2.5.2.

Deletion has to be reconfirmed by pressing the  key.

7.2.5.4 Process Slave

"Process Slave" signifies the configuration of Slave-related parameters, editing / modifying / deleting of tag definitions of the Slave operation, as well as activating the Slave through PROFIBUS single services. Details of this option are described in detail in chapter 7.3.

7.3 Process Slave

Process Slave is the core PROFIBUS Master functionality of the NetTEST II.

Selection of the Slave to be edited takes place analogously to the selection of the Slave to be copied in chapter 7.2.5.2.

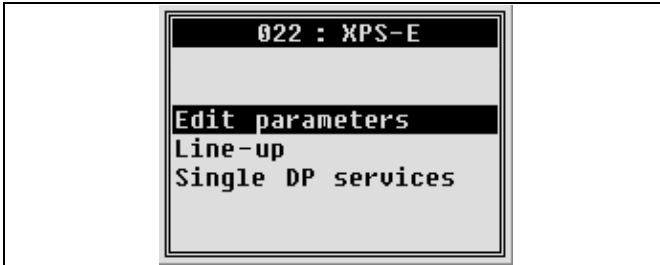

Figure 50: Screen 'Process slave'

7.3.1 Edit parameters

With *Edit parameters* another menu selection is entered, that further defines the possible parameters.

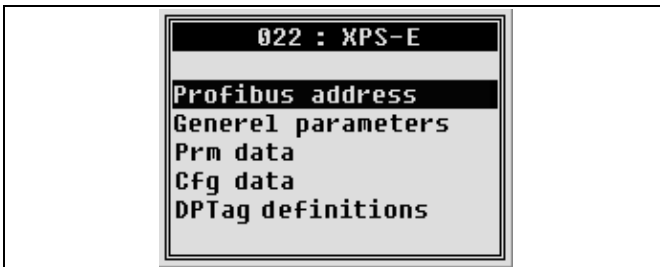

Figure 51: Screen 'Edit parameter'

7.3.1.1 PROFIBUS address

Changing these parameters takes place analogously to editing a Slave (see chapter 7.2.5.1).

7.3.1.2 General parameters

Changing these parameters takes place analogously to editing a Slave (see chapter 7.2.5.1).

7.3.1.3 Prm data

Changing these parameters takes place analogously to editing a Slave (see chapter 7.2.5.1).

7.3.1.4 Cfg data

Changing these parameters takes place analogously to editing a Slave (see chapter 7.2.5.1).

7.3.1.5 DP tag definitions

Selecting this menu option launches the Tag editing menu). The user may find further documentation in chapter 7.4 DP.

7.3.2 Line-up

Selecting ***Line-up*** will start the DP State Machine in the **NetTEST II** for the currently selected Slave.

The PROFIBUS services "SET_PRM_REQ", "CHK_CFG_REQ" and "SLAVE_DIAG_REQ" continue to be performed in this case until the result of the "SLAVE_DIAG_REQ" signals that the Slave is ready for the "DATA_XCHG_REQ".

Thereafter, the "DATA_XCHG_REQ" service is performed cyclically. If the Slave signals a diagnostic change, the **NetTEST II** reads the diagnostic data from the Slave. The diagnostic data can then be viewed in the 'Show Slave diagnostic' (see chapter 7.3.2.10).

These (cyclic) services are processed by a "background process", while the system remains responsive on the user side.

The Slave communication state is shown on the last display line. Thus, the user can check every time whether the communication with the Slave functions or whether a parameter / configuration problem persists.

Possible messages on this line could be:

- **"No Answer"**
No communication with the Slave can be established (e.g. wrong address).
- **"Param_Fault !"**
Parameterization of the Slave is incorrect.
- **"Cfg_Fault !"**
Configuration data of the Slave are incorrect.
- **"Not_Ready"**
The Slave is not (yet) ready for data exchange.
- **"Param_Req !"**
The Slave expects parameterization by the Master.
- **"DATA_EXCHANGE"**
The Slave was properly parameterized and configured. Data exchange is taking place
- **"DATA_EXCHANGE !"**
The diagnostic data at the Slave has changed. By selecting the menu 7.3.2.10 Show Slave diagnostic the diagnostic data can be displayed and the '!' in the display will be acknowledged.

There is an additional submenu for changing the configuration data or the output data or displaying the input data of the Slave.

7.3.2.1 Line-up

The user herewith has the opportunity to constantly modify Slave configuration data in the case of uncertainty about the right configuration.

Moreover, if the Slave has reached the "Data-Exchange" status, the user can modify output data (to the Slave) or, display and evaluate input data (from the Slave).



Figure 52: Screen 'Line up'

7.3.2.2 Edit slave address

With this option the user can modify the PROFIBUS address of the Slave. Address selection takes place over the address menu (see chapter 7.2.5.1).

7.3.2.3 Edit slave parameters

The user can view / modify several more important parameters. Modification of these parameters functions in the same way as described in chapter 7.2.5.1.

7.3.2.4 Edit prm. data

Here, the user can view / modify the user-specific parameters. Modification of these parameters functions in the same way as described in chapter 7.2.5.1.

7.3.2.5 Edit cfg. data

Here, the user can view / modify the configuration data for the CHK_CFG_REQ service. Modification of these parameters functions in the same way as described in chapter 7.2.5.1.

7.3.2.6 Edit xchg. data

Here, the output-data for the Slave can be entered. Changing these values functions in the same way as described in chapter 7.2.5.1.3.

7.3.2.7 Show xchg. data

Input data received by the Slave are displayed here. (The data packets sent cyclically from Slave to Master). These values may not be changed.

7.3.2.8 Edit DPTag output

This option opens a submenu, out of which the user may select one of the defined output tags. Thereafter, he has the option of entering data corresponding to the type of the tag.



This is above all very helpful when sending float values to the Slave.

7.3.2.9 Show DPTag input

This option opens a selection menu, where the user may select one of the defined input tags. Thereafter, the data corresponding to the type of the tag are displayed.

7.3.2.10 Show Slave diagnostic

In case the diagnostic data of the edited Slave changes, the **NetTEST II** signals this through a '!' followed by the message "DATA EXCHANGE" in the last line.

This option reads out the diagnostic data and displays them in a decoded mode as far as possible. Due to the fact, that the SLAVE_DIAG_REQ Service was performed, the Slave resets this flag until the new diagnostic data occur.

7.3.3 Single DP services

By selecting **Single DP services** single PROFIBUS services for the currently selected Slave can be performed.

The following PROFIBUS services are integrated in the **NetTEST II**:

- SET_PRM_REQ
- CHK_CFG_REQ
- SLAVE_DIAG_REQ
- DATA_EXCHG_REQ
- GET_CFG_REQ
- SET_SLAVE_ADDRESS_REQ
- GLOBAL_CONTROL_REQ
- RD_OUTP_REQ
- RD_INP_REQ

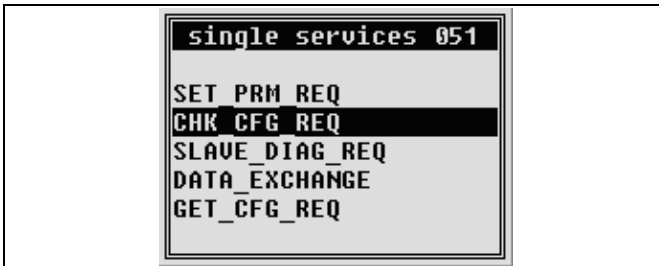

Figure 53: Screen 'Single DP services'

7.4 DP Tag definitions

In order to depict and modify I/O data of a DP Slave in a more easy way, the **NetTEST II** allows definition of so-called "tags". A "tag" is to be imagined as a data extraction from the I/O data of a DP Slave. As data transport can be in principle possible in two directions, there are thus input or output tags.

Example: A DP Slave has 8 digital outputs, which may be set or reset over the first output Byte. **NetTEST II** makes it possible to define in this output Byte per Bit a tag of Boolean type, over which the corresponding output may be specifically controlled. The corresponding *Configurator-Tool* also allows definition of these tags comfortably over the PC.

Properties of tags:

- Name
- Type (e.g.: Boolean, Int, Real)
- Sign (in part implied in the type e.g.: Real)
- Byte – orientation (big endian / little endian = MOTOROLA / INTEL)

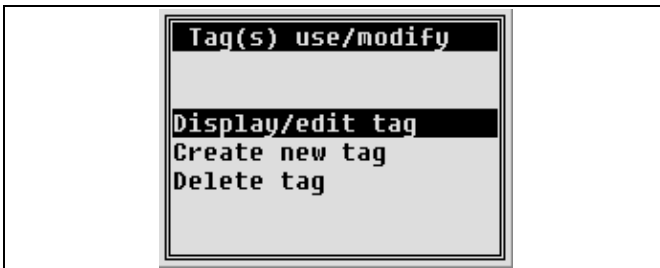

Figure 54: Screen 'Tag(s) use / modify'

7.4.1 Display / edit tag

In order to *Display / edit tag*, one of the tags from the tag selection menu must be selected.

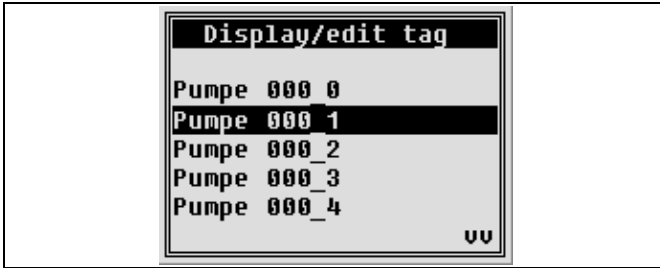

Figure 55: Selection menu 'Display / edit tag'

By choosing one of the entries, the tag parameters may be displayed / edited.

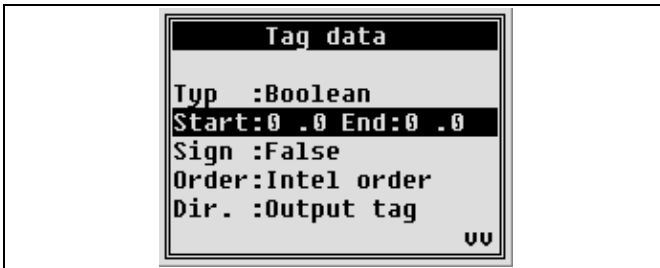

Figure 56: Entry mask 'Tag data'

A particularity of the tag properties is the bit-granular resolution in the core image of the PROFIBUS Slave. In the tag properties mask, the tag-start is defined by <Startbyte.Startbit> and the tag-end by <Endbyte.Endbit>.

7.4.2 Create new tag

By selecting **Create new tag** a new tag may be entered. For entering the tag properties please use the same properties mask as in chapter 7.4.1 (Display / edit tag)

7.4.3 Delete tag

When selecting **Delete tag** the same tag selection menu opens as in chapter 7.4.1 (Display / edit tag). By selecting one of the tags from the list the corresponding definition may be deleted.

8 System with online functionality

Devices with activated online functionality can be identified by their modified "PROFIBUS" screen start-up logo, depicted below.

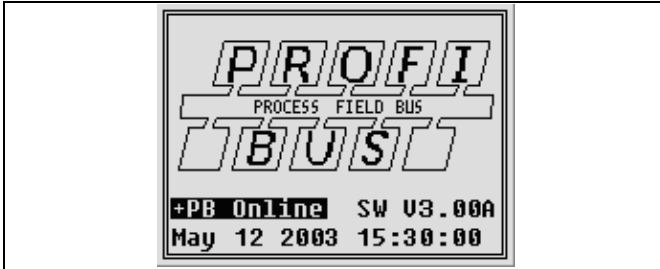

Figure 57: "Start-up" Screen with Online Function

The **NetTEST II** – online functions can be selected in a *Line test* menu item within the Line test menu list.

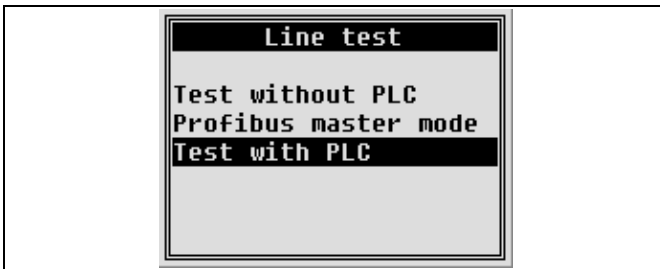

Figure 58: Screen Line test

The **NetTEST II** uses the online functions while operating in a completely passive monitoring mode. The equipment performs a detailed analysis of the telegram traffic and the physical state of the PROFIBUS line.

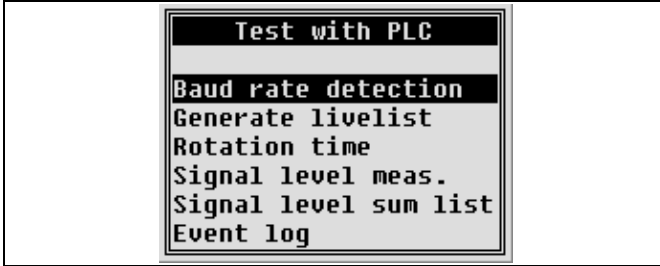

Figure 59: Screen Test with PLC

In the following the online functions *Tests with PLC* are listed:

- Baud rate detection (chapter 8.1)
- Generate livelist (chapter 8.2)
- Rotation time (chapter 8.3)
- Signal level measurement (chapter 8.4)
- Signal level summary list (chapter 8.5)
- Event log (chapter 8.6)
- Event count (chapter 8.7)
- Diagnostic event (chapter 8.8)

☞ The DP Slave oriented signal level measurement can be very time-consuming in connection with low baud rates or low data traffic .

The **NetTEST II** can be connected directly to a free PROFIBUS plug in the network. Also, connection between a PROFIBUS plug and the respective DP Slave via an adapter cable (PROFIBUS Y-cable, see accessories) is possible. In general, you should exercise care in connecting the **NetTEST II** to running bus systems. At higher baud rates (≥ 1.5 Mbit) spur lines are strictly forbidden, because the data traffic may be significantly disrupted.

8.1 Baud rate detection

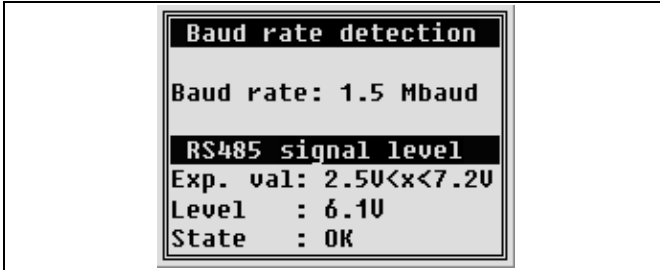

Figure 60: Baud rate detection

With the function *Baud rate detection* the current baud rate on the running PROFIBUS is displayed. During the baud rate scan additionally the all over signal level on the PROFIBUS is measured and evaluated.

- U < 2.5 V: Weak level or no longer detectable.
- 2.5 - 7.2 V: Level is ok.
- U > 7.2 V: If the indicated level is > 7.2 Volt, this is an indication for a faulty power supply of the Slaves or for reflections at the bus.

8.2 Generate livelist

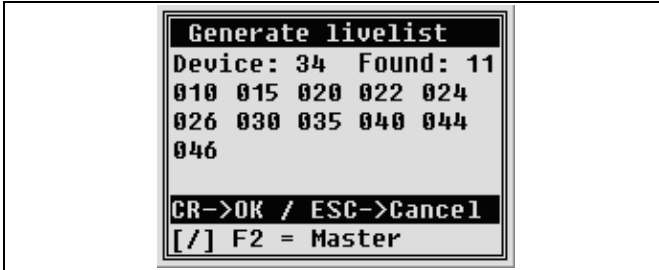

Figure 61: Generate Slave livelist

With the function *Generate livelist* the NetTEST II displays all active DP Slaves in connection with a DP Master. All active DP Masters may be displayed as well using the **F2** key.

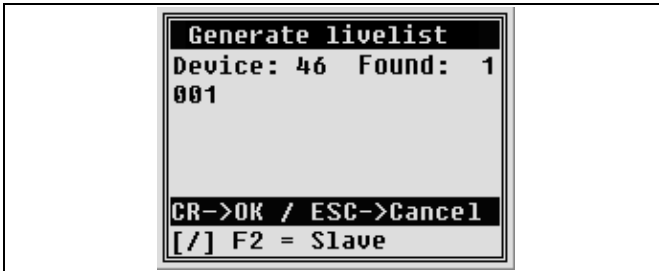
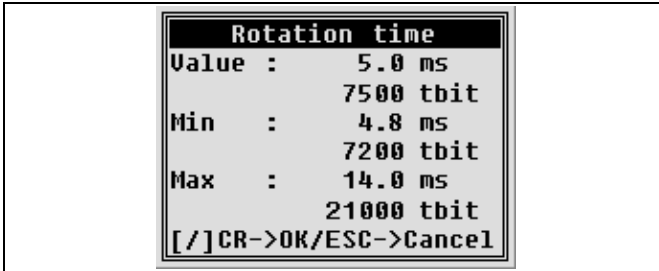

Figure 62: Generate Master livelist

- ☞ The DP Master detects a new DP Slave on the PROFIBUS by sending out an *FDL-Request*. The device counter in the display (Device: XX) indicates, in which address range (0-127) the DP Master is scanning.

8.3 Rotation time



The screenshot shows a terminal window with a title bar that reads "Rotation time". The content of the terminal is as follows:

Rotation time	
Value :	5.0 ms
	7500 tbit
Min :	4.8 ms
	7200 tbit
Max :	14.0 ms
	21000 tbit
[/]CR->OK/ESC->Cancel	

Figure 63: Rotation time

The **Rotation time** is the time the DP Master needs to poll all configured DP Slaves once. The minima and maxima values measured here are saved and displayed. The rotation time is an unambiguous indicator for performance problems, i.e. in a sporadic non-functional DP network. Moreover, the **NetTEST II** informs whether the PROFIBUS project planning meets system requirements, as the PROFIBUS overall rotation time must in any case be smaller than the system reaction time required.

- ☞ Tbit is the time measurement unit for the transmission of a single Bit on the PROFIBUS, depending on the baud rate. For example: 1 Tbit with 12 Mbaud = $1/12.000.000$ Bit/s = 83 ns.

8.4 Signal level measurement

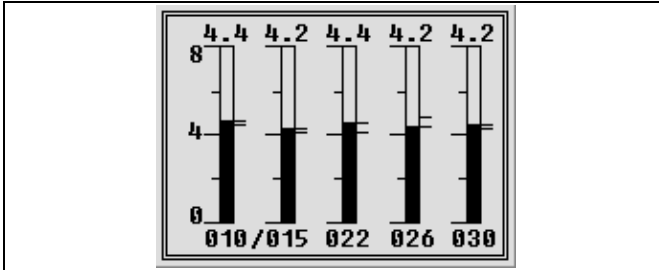

Figure 64: Signal level measurement

The **NetTEST II** measures the RS485-driver output level of each individual DP Slave and displays them in a bar graph. Below the bar graph the DP Slave address is indicated. Above the bar graph the actual RS485-driver output level appears in Volt. The minima and maxima values are stored right beside the bar graph as a scale line symbol. The rotating slash indicates the DP Slave actual measured. In the menu **Settings** (see Chapter 8.9) the duration of the single measuring can be increased, which enables the measuring even of very slow DP Slaves. Only the visible DP Slaves (max. 5) are measured. By means of the **← →** key the display window can shifted to switch to the remaining DP Slaves. If in the menu **Settings** (see Chapter 8.9) Level scrolling is activated, the display window is automatically shifted to display always the actual measured DP Slaves, which guarantees a complete level measurement with all selected DP Slaves. Any discrepancies of the levels in comparison to the nominal range indicate severe PROFIBUS network problems.

- $U < 2.5 \text{ V}$: Weak level or no longer detectable.
- $2.5 - 7.2 \text{ V}$: Level is ok.
- $U > 7.2 \text{ V}$: If the indicated level is $> 7.2 \text{ Volt}$, this is an indication for a faulty power supply of the Slaves or for reflections at the bus.

The level measurement can be conducted by means of the current livelist or a defined filter.

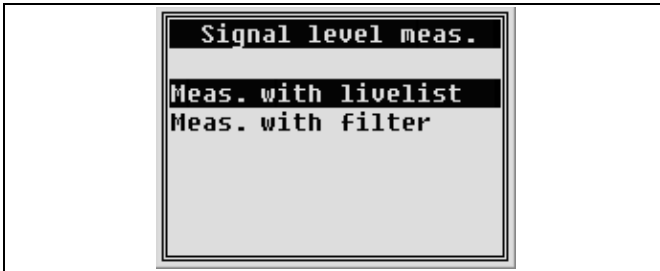

Figure 65: Selection menu Signal level measurement

8.4.1 Measurement with livelist

For all DP Slaves contained in the current livelist a level measurement is performed.

8.4.2 Measurement with filter

For *Measurements with filter* the bar graph display can be adapted to the spatial distribution of the network. A filter consists each of a name, a list of stations and their order.

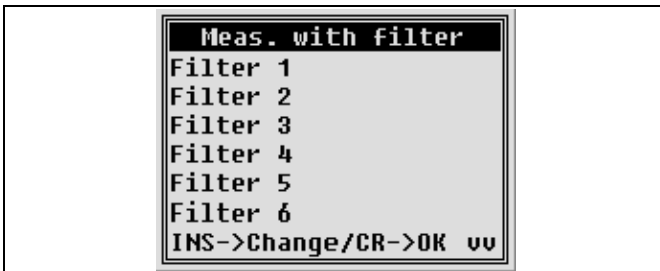

Figure 66: Measurement with filter

8.4.2.1 Define filter

In the menu *Define filter* network specific data can be configured for the subsequent *Level measurement*. The data is stored in the data base under the selected filter name. In the following every single step for the filter definition is described:

1. A *filter name* with up to 30 characters can be defined:



Figure 67: Screen 'Filter name'

2. In the *DP Slave list* the DP Slaves for the level measurement can be selected. By means of keys **INS** or **DEL** a DP Slave may be added or dropped:



Figure 68: Screen 'DP Slave list'

- ☞ All livelist members are indicated in the *DP Slave list* as either LL Master (livelist DP Master) or LL Slave (livelist DP Slave).

- The DP Slave selected in step 2 may be moved in the *DP Slave sorting* by means of keys **DEL** or **INS** :

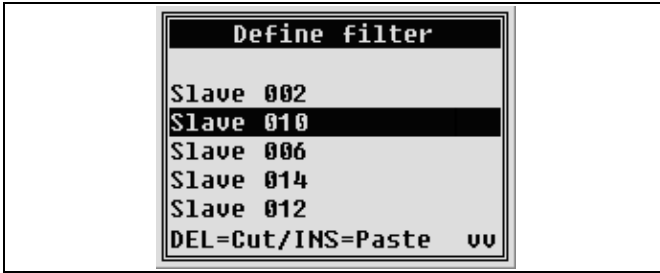

Figure 69: Screen 'DP Slave sorting'

8.5 Signal level summary list

ADD	COUNT	MIN	AV	MAX
010	48	4.2	4.3	4.4
015	48	4.1	4.2	4.2
020	43	4.1	4.3	4.4
022	41	4.2	4.2	4.4
024	41	4.2	4.2	4.3
026	43	4.3	4.3	4.3

uu

Figure 70: Screen 'Signal level summary list'

In the *Signal level summary list* the result of the *level measurement* is displayed in table format.

- ADD – Station Address
- COUNT – Number of measurements (excl. timeouts)
- MIN – Minima value
- AV – Average value
- MAX – Maxima value

8.6 Event log

ADD	DATA	TRY	CFG	DIA
010	OK	*	-	-
015?	OK	-	-	-
020	OK	*	-	-
022	NR	*	*	*
024	OK	-	-	-
026	OK	-	-	-
[/]F2=Reset/F3=Redo vv				

Figure 71: Screen 'Event log'

In the menu *Event log* the **NetTEST II** analyses the data traffic between DP Master and DP Slaves and shows all changes of the communication state for every DP Slave. The *Event log* is depicted in the form of a table. The columns are described as follows:

- ADD
 - Station address
 - ADD? – upon request by DP Master an error telegram occurred
- DATA
 - OK – DP Slave is in state DATA_EXCHANGE
 - NR – No Response, DP Slave is not responding
- TRY
 - DP Slave needs more than 1 request by the DP Master
- CFG
 - DP Slave was parameterised or configured
- DIA
 - Diagnostic messages occur at the DP Slave

Normally, a correctly configured DP Slave connected to the DP Master indicates the status "OK – data exchange". During long-term operation the PROFIBUS network all specific changes of the network can be monitored. Even DP Slaves of the DP Master not yet configured but nevertheless part of the livelist, are displayed. By means of the **F2** key the event log can be reset. The event log is updated by pressing the **F3** key or after expiration of the adjusted event update time (see chapter 8.9).

8.7 Event count

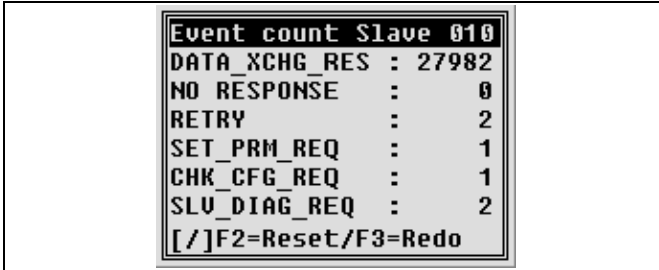

Figure 72: Screen 'Event count'

A problematic DP Slave, detected by the event log, can be examined in detail by the *Event count* function. The function *event count* displays in principle the same events as the *Event log*, but the status changes of the DP Slave can be analysed in detail. The following events are counted (0 - 99999):

- DATA_XCHG_RES (DATA)
 - Station is in state DATA_EXCHANGE.
- NO_RESPONSE (DATA)
 - DP Slave does not respond.
- SET_PRM_REQ (CFG)
 - DP Slave was parameterized.
- CHK_CFG_REQ (CFG)
 - DP Slave was configured.
- SLV_DIAG_REQ (DIA)
 - Diagnostic messages occur at the DP Slave.
- TRY (DATA)
 - Number of repeated requests by the DP Master until the DP Slave responds.
- ERR (DATA)
 - Error Telegram upon request by the DP Master.

By means of the **F2** key the event count display can be reset. The event log is updated by pressing the **F3** key or after expiration of the adjusted event update time (see chapter 8.9).

8.8 Diagnostic event

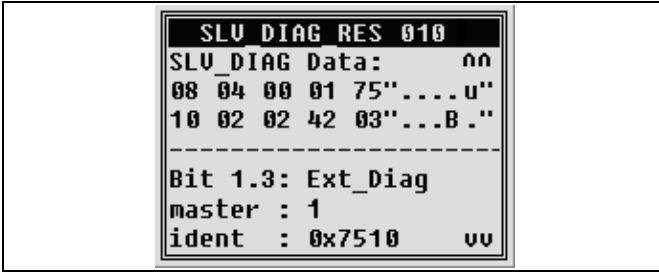

Figure 73: Screen 'Diagnostic event'

The *Diagnostic event* is an extended function of the *Event count* and provides the detailed analysis of an event. **NetTEST II** offers a selection of 6 different events that may be triggered. With the occurrence of the selected event all relevant data are displayed. Depiction is in plaintext as far as possible, depiction in binary / ASCII mode is also possible. The following events can be selected:

- SET_PRM_REQ (Parameter data which the DP Master transmits to the DP Slave)
- CHK_CFG_REQ (Configuration data which the DP Master transmits to the DP Slave)
- SLV_DIAG_RES (Diagnostic data which the DP Slave transmits to the DP Master)
- DATA_XCHG_REQ (Output data transmitted to the DP Slave)
- DATA_XCHG_RES (Input data received from the DP Slave)
- GET_CFG_RES (Configuration data which the DP Slave transmits to the DP Master)

By means of the **F2** key the event count display or the diagnostic event can be reset. The event count display is updated by pressing the **F3** key or after expiration of the adjusted event update time (see chapter 8.9).

8.9 Settings

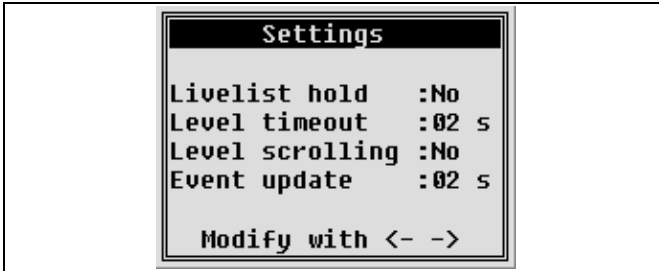

Figure 74: Screen 'Settings'

In the menu *Settings* the following properties regarding the online functions may be selected:

- Livelist hold (Yes / No, Default: No)
 - If the livelist hold is activated, also sporadically detected DP Slaves at the PROFIBUS are stored in the livelist.
- Level timeout (2s, 5s, 10s, 60s, ~, Default: 2s)
 - If the adjusted level time expires, the level measurement is proceeded with the next DP Slave. With "~" adjusted, **NetTEST II** waits endless for a valid level measurement with the actual DP Slave. This can be useful in connection with low baud rates or very slow DP Slaves.
- Level scrolling (Yes, No, Default: No)
 - With Level scrolling activated, the bar graph display is automatically shifted to display always the actual measured DP Slave which guarantees a complete level measurement with all selected DP Slaves.
- Event update (2 s, 5 s, 10 s, 60 s, ~, Default: 2 s)
 - The event update is responsible for the event protocol, for the event count and for the diagnostic event. If the set update time is reached, then the display window is updated. During updating events occurring at the PROFIBUS cannot be registered. Thus, it is recommended to set to '~', especially for higher baud rates ($\geq 1,5$ Mbit) and to update the display window manually by means of the key **F3**.

9 Operation of the Battery Charger

The battery charger comes in two components: a desktop battery holder and a plug charger. Connect the desktop holder with the plug charger. Insert a **NetTEST II** battery into the battery holder. Now plug in the charger plug into a 230 VAC mains socket. Check the charging process by means of the control LED of the battery charger, it is a “time charger”. Charge time starts with mains ON and lasts for approx. 6 hours. During this time, the charge control lamp, is on (if a battery is in the charger). When the charge cycle is finished, the unit automatically switches over to maintaining charge. The charge control lamp then blinks in the interval 5 seconds “ON”, 20 seconds “OFF”.

- ☞ Avoid quick insert / removal of the battery into the battery holder, because the battery charger may be left in an undefined state. Wait approx. 5s after removal before you insert the next battery into the battery holder.

10 Tips & Tricks

10.1 Cable Lengths in PROFIBUS segments

The maximum cable lengths of PROFIBUS segments are specified in the standard EN 50170, part 2, in dependency from the transmission rate used. Here, the indicated value applies only for segments with copper cables type A, without using repeaters.

The following table shows the maximum segment lengths, depending on the baud rate:

Transmission rate	Max. segment length
9.6 Kbit/s	1200 m
19.2 Kbit/s	1200 m
45.45 Kbit/s	1200 m
93.75 Kbit/s	1200 m
187.5 Kbit/s	1000 m
500.0 Kbit/s	400 m
1.5 Mbit/s	200 m
3.0 Mbit/s	100 m
6.0 Mbit/s	100 m
12.0 Mbit/s	100 m

Table 1 Segment length specification

10.2 Segment Cascading

According to the standards it is permissive to make a cascade connection with 4 cable segments, separated by repeaters. For individual applications this guideline can be deviated from. However, if there should be sporadic errors in the bus segment, we recommend a timing check with a bus monitor, and possibly a reduction to the specified 4 segments.

10.3 Use of stub lines

When speaking about stub lines, one must distinguish between active and passive stub lines. Active stub lines can be, e.g. repeaters or optical couplers. They do not have any negative influence on the signal quality of the bus. Passive stub lines, however, (e.g. bus terminals or simple cable stubs), have to be avoided in every case. In general, it is claimed that with low baud rates (< 500 Kbit/s) no or only minor reflections occur, however, this does not comply with the reality. The reflections are there, even if they might not affect the data traffic with low baud rates, as there is enough time for the signal to transiently match the corresponding value.

11 Pin Assignment

NetTEST II disposes of only one 9-pin D-SUB connector. This can optionally be switched to PROFIBUS or RS232 mode.

Pin	PROFIBUS	RS232
1	nc	nc
2	-	RxD
3	TxD/RxD + (B)	-
4	-	GND
5	nc	nc
6	nc	nc
7	-	TxD
8	TxD/RxD - (A)	-
9	nc	nc
Shield	Shield	Shield

Table 2 Pin assignment of D-SUB 9 connector

12 Key Allocation

NetTEST II is equipped with a 24-key matrix keyboard. In order to be able to enter also alphanumeric characters for the manifold data memories, the following table shows the multiple key allocation:

Key	1 st push	2 nd push	3 rd push	4 th push	5 th push	6 th push	7 th push	8 th push
1	()	/	&	=	,	1	
2	a/A	b/B	c/C	2				
3	d/D	e/E	f/F	3				
4	g/G	h/H	i/I	4				
5	j/J	k/K	l/L	5				
6	m/M	n/N	o/O	6				
7	p/P	q/Q	r/R	s/S	7			
8	t/T	u/U	v/V	8				
9	w/W	x/X	y/Y	z/Z	9			
0	.	,	;	:	?	!	0	
ESC	*							
#	Blank	"	\$	-	%	@	_	#
*	a→A/*							
INS	Insert							
DEL	Delete							
F1	Help on	Help off						
F2	Save Reset							
F3	Redo							
↵	Enter							
⏻	ON/OFF							
←	Cursor left							
→	Cursor right							
↑	Cursor up							
↓	Cursor down							

Table 3 Key allocation NetTEST II

13 Problematic Slaves

Currently, **COMSOFT** knows of four PROFIBUS DP Slaves with problematic bus behaviour:

These are, in particular, the following systems:

- Pepperl & Fuchs DP/PA-Koppler KDF2
- Beckhoff / Wago older model of bus terminal (97-98)
- Siemens ET200 B older model (96-98)
- IFM-Electronic DP/ASI-Gateway AC 0005/AC 0006

The problems result either from capacitive / inductive screening measures on the PROFIBUS signal lines, or from excessively long spur lines within the DP Slaves. During the line tests with **NetTEST II** these devices causes the error message *"Error: A<->B Capacitive load, junction or Impedance changes"*

For correct measurement of the PROFIBUS physics these devices are to be disconnected from the line.

It may not be excluded that in the future, more PROFIBUS subscribers may become apparent through similar bus behaviour. However, DP Slaves, that contain these screening measures do no longer pass official certification tests by accredited test labs.

14 Frequently Asked Questions: FAQ

- Can **NetTEST II** also make measurements beyond a physical separation of the bus (e.g. via repeaters or optical couplers)?
No, physical measurements via such bus connectors are not possible, as these completely disconnect the segments by its incorporated drivers.
- Can **NetTEST II** also detect devices connected to the bus via a Siemens PA-Link?
No, this is impossible, as the PA-Link operates as an individual Slave in the bus, and there, during a Slave diagnosis, only the address of the PA-Link is visible.
- Is it possible to indicate exactly the fault position, e.g. short circuit A-B between Slave 24 and Slave 25?
This is certainly desirable, but impossible due to the physical conditions of the PROFIBUS segment.
- Does **NetTEST II** line test also work with other RS485 based buses?
If, on the other bus, no bus terminators are installed, also any other RS485 based bus can be tested. However, as the correct termination is specifically made out to the PROFIBUS terminators, the tool is rather unsuitable for testing other bus systems.
- Why can the line test only be performed at the non-active bus?
*For checking the line physics, **NetTEST II** carries out static level detection, as well as reflection measurements. If there was one active master at the bus, this would strongly influence the measurements, and make them useless.*
- Can **NetTEST II** make the tests in any place within a PROFIBUS segment?
No. The physical line analysis can only be made from one bus end. The other protocol-specific tests can be made from any connection in the segment.

- How is the connection to be made, if only participants with PG screwing resp. screw terminals are connected to the bus?
Should these participants be placed at both bus ends, the user must provide an additional D-SUB connector for test purposes. COMSOFT will soon offer a spring clip terminal block as accessory for the one core connection. Please ask our sales department for availability.
- Can **NetTEST II** detect double allocated PROFIBUS DP Slave addresses?
No, sorry, in the current version this is not possible. We are working on a clear detection of such errors.
- Is it possible to implement in **NetTEST II** a PROFIBUS bus monitor for monitoring the telegram traffic on the bus?
No. For monitoring telegrams, neither the screen possibilities nor the memory are sufficient.
- Can **NetTEST II** also perform further test functions, e.g. parameterization and configuration of a Slave ?
Yes, parameterization and configuration of a PROFIBUS DP Slave is possible with the DP Master Option. With this option it is also possible to line-up a DP Slave. If a DP Slave supports the Set_Slave_Addr Service, the address of the DP Slave can be changed.

15 Technical Data

15.1 NetTEST II

Display	LCD 128 x 64 pixel Matrix Screen with background illumination and protective glass
Keyboard	4 x 6 Key Silicone Keyboard
Loudspeaker	Piezo-Beeper
Quartz clock; Backup without battery	$t \geq 14$ tags
Connections	DB9 connector
PROFIBUS data rates	9600 bit/s - 12 Mbit/s
PROFIBUS Slot Time Range	300 – 5000
RS232 data rates	300 - 115200 bit/s
RS232 interface protocol (Data bits/parity/stop bit)	7E1, 7E2, 7O1, 7O2, 7N1, 7N2, 8E1, 8E2, 8O1, 8O2, 8N1, 8N2
RS232 – protocol	Kermit
Test area cable length	5 m ... 1500 m
Measuring inaccuracy with connected devices	$\pm 5 \%$
Measuring inaccuracy without connected devices	± 2 m
Measuring area line impedance	0 Ω - 250 Ω
Measuring inaccuracy line impedance	$\pm 5 \%$
Measuring range RS485 level	0.0 Vss ... 8.0 Vss
Measuring inaccuracy with level detection	± 200 mV
Dimensions	230 x 98 x 53 mm
Weight with battery	530 g
Battery	4.8 V / 1500 mAh NiMH
Operating duration with one battery	$\geq 4,5$ h without background illumination ≥ 4 h with background illumination
Operating temperature range	+ 10°C ... + 40°C
Storing temperature	- 20°C ... + 45°C
Class of protection	3

Technical Data

Degree of Protection	IP50
Certification	DIN EN 61326-1

Table 4 Technical data **NetTEST II**

15.2 Plug Charger

Input voltage range	100-240 VAC, 50-60 Hz
Max. input current	120 mA
Power input	Max. 12 VA
High voltage check	4 kV
Charge voltage	4.8-12 VDC
Charge current	Max. 600 mA
Charge time NetTEST II Battery	3.5 h
Red LED	The red LED plays different roles: <ol style="list-style-type: none">1. Signalise the faultless contact of the rechargeable battery during the test period (approx. 10 min)2. Signalise the right polarity of the rechargeable battery3. Signalise a defect rechargeable battery or a wrong number of cells4. Signalise the discharge after pushing the discharge key
Green LED	Rechargeable battery is charged, pulse-conservation charging
Output line	1.8 m
Dimensions (w x h x d)	60 x 47 x 106 mm
Weight	280 g
Operating temperature range	0°C ... + 30°C
Storing temperature	- 40°C ... + 70°C
Certification	CE

Table 5 Technical data Plug charger